



# SCE6000A

## SANY Crawler Crane

### 600 Tons Lifting Capacity

Quality Changes the World



**Max. lifting moment: 7200t·m**

**Longest boom: 84m**

**Longest boom+jib: 84m+84m**

The parameters, pictures and standard/optional equipment are only for reference in this brochure, the actual machine is based on the effective price list and contract.

■ [www.sanyglobal.com](http://www.sanyglobal.com)



**Crawler Crane Series**  
**SCE6000A**

P03	Main Characteristics	<ul style="list-style-type: none"> <li>▪ Product Specification</li> <li>▪ Safety Devices</li> </ul>
P09	Technical Parameters	<ul style="list-style-type: none"> <li>▪ Major Performance &amp; Specifications</li> <li>▪ Outline Dimension</li> <li>▪ Transport Dimensions</li> <li>▪ Transport Plan</li> <li>▪ Self-Assembly Plan</li> </ul>
P27	Cofigurations	<ul style="list-style-type: none"> <li>▪ Configuration</li> <li>▪ H Configuration</li> <li>▪ HDB Configuration</li> <li>▪ HJ Configuration</li> <li>▪ HJDB Configuration</li> <li>▪ HJFJ_3 Configuration</li> <li>▪ HJFJDB_6 Configuration</li> <li>▪ LJ Configuration</li> <li>▪ LJDB Configuration</li> <li>▪ ZH Configuration</li> <li>▪ ZHDB Configuration</li> <li>▪ ZLJ Configuration</li> <li>▪ ZLJDB Configuration</li> <li>▪ FJh Configuration</li> <li>▪ FJhDB Configuration</li> </ul>



**SCE6000A**  
**SANY CRAWLER CRANE**  
**600 TONS LIFTING CAPACITY**

QUALITY CHANGES THE WORLD

## Main Characteristics

- Page 04 Product Specification
- Page 07 Safety Devices

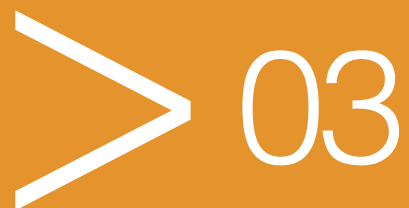

## Product Specification



### Engine

- Model: X15 Cummins America (compiled with European Non-road Tier VI Emission Standard);
- Type: water-cooled, vertical in-line 6 cylinders, electrical control, turbo-charger, charge air cooling system;
- Displacement: 15L;
- Rated power: 447kW/1800rpm;
- Operation power: 447kW/1800rpm;
- Max. Torque: 2779N·m/1400rpm;
- Starter: 24V-8.5kw;
- Batteries: Four 12V×180Ah capacity batteries;
- Fuel tank capacity: 1000L.

### Electrical Control System

- Self-developed SYIC-I integrated control system is adopted with higher integration, precise operation and reliable quality;
- Control system consists of power system, engine system, main control system, LMI system, auxiliary system and safety monitoring system;
- Main electrical components are from internationally or industrially well-known brands, and they can perform stably in such bad environment as in severe low or high temperature, plateau, and sandstorms. The design with multi-stage safety limits and kinds of safety signal indicators, totally complies with CE Standard;
- LMI, combined monitors and closed circuit monitor are directly visible to operator. LMI detects the lifting moment and other status; combined monitors display operation conditions, limited status under control and alarms; closed circuit monitor monitors working conditions of the winch and rear parts. For armrest boxes at both sides, there are three operation levers, and the button switches the control functions, so the function elected and respective operating range of the lever will appear on the monitors;

### Hydraulic System

- Main pumps: five close piston pumps of electronic proportion are adopted to provide oil supply for main actuators of main machine;
- Assisting pump: electronic proportion open piston pump, providing oil for assisting cylinder;
- Back-stop pump: load-sensitive feedback pump, providing oil for back-stop system;
- Gear pump: dual-gear pump for oil-boosting system, oil radiator, A/C control circuit;
- Control: closed main pump adopts electronically controlled system, and the electronic lever controls the closed the pump and variable-placement motor;
- Rated pressure of main system: 35MPa;
- Rated oil boosting system: 3.5 MPa;
- Hydraulic Tank Capacity: 800L;
- Components: hydraulic system of load hoisting, traveling, swing, hoisting and luffing, servo, anti-backstop, cooling, aux. system. Main components are all imported originally;
- Features: Closed circuit is adopted for all load hoisting hydraulic, traveling hydraulic, luffing hydraulic and swing hydraulic system, featured by saving energy, high-efficiency, fast-reaction, low heat emission, and long service life;
- Servo hydraulic system adopts electronic proportion controlled components for accurate and smart control;
- Backstop hydraulic system adopts external-controlled releasing balance valve on the hydraulic, safety and reliable;
- Cooling system is featured with high radiating power and excellent cooling result.

### Cab and Control

- Fully-enclosed steel frame structure and large area of glass window at front, sides and top make brightened cab with broaden view. The floating, damping and de-noising, and multi-stage adjusted seat, and air conditioner enable better operating experience. There are control lever, control button and ignition lock fitted in the right and left armrest box and assisting control box. The low noise (less than 85dB), the ergonomically designed seat and buttons realize more comfortable operation. The cab can tilt up from 0°~24° for broaden view and rotates to the front of the platform for convenient transport.

### Closed Circuit Camera System

- The camera system is fitted with two monitors and multi cameras, each monitor displaying four pictures simultaneously at most, realizing real-time monitoring the rope rotating of the winch drum, lifting status of the superlifting counterweight and surrounding;
- The system is equipped with recording function, and longest reserving time can be up to 76 hours, providing reference to the operation and accident.



## Product Specification

### Main and Aux. Load Hoist Mechanism

- A variable hydraulic motor drives the planetary gear reducer to control the lifting and lowering of main hoists I and II. A good inching performance is provided. The highest speed can be realized through main hoist I and II. Synchronization function is designed. One hoist for load less than 225t, dual main hoists work at the same time for load exceeding 225t; When single rope pull of any main hoist is larger than 6t, the synchronization function acts, winching speed of out most layer reaches 140m/min, and the largest parts of line is 36. Multiple layers of wire rope on fold-line drum can avoid messing rope. The gearbox is quiet and efficient, with longer service life and convenient fuel change.

Main load hoist mechanism I	Drum diameter	630mm
	Rope speed on the outermost work layer	0~140m/min
	Wire rope diameter	28mm
	Wire rope length of main hoist I	870m
	Rated single line pull	17.8t
Main load hoist mechanism II	Drum diameter	630mm
	Rope speed on the outermost work layer	0~140m/min
	Wire rope diameter	28mm
	Wire rope length of main hoist II	870m
	Rated single line pull	17.8t

### Boom/Jib/Superlift Hoist Mechanism

- Including: luffing mechanisms of the boom, jib and superlift;
- All luffing winches adopt fold-line drums, which are driven by hydraulic motor through the planetary gear box and can realize a number of compound actions and good inching performance.

Boom hoist mechanism	Drum diameter	630mm
	Rope speed on the outermost work layer	(0~70)×2m/min
	Wire rope diameter	28mm
	Wire rope length of boom hoisting	600m
Jib luffing mechanism	Drum diameter	630mm
	Rope speed on the outermost work layer	0~110m/min
	Wire rope diameter	28mm
	Wire rope length of jib luffing	730m
Superlift mast luffing mechanism	Drum diameter	630mm
	Rope speed on the outermost work layer	0~110m/min
	Wire rope diameter	28mm
	Wire rope length of superlift luffing	800m

### Swing Mechanism

- Swing hydraulic system adopts dual motors and is driven by the the planetary reducer via gear. It can realize 360° swinging range, infinitely variable swing speed of 0~0.86r/min, and steady free flipping function, without shocking at start and stop.
- Swing ring: three-row roller external-engaged bearing.

### Carbody

- The hydraulic cylinder drives power pin to be connected with track frame to facilitate the assembly and disassembly. Frame structures are welded by high-strength steel. Larger chassis design greatly improves the stability of the crane;
- Carbody counterweight: Total weight:50t, each 25t at rear and front, including counterweight tray: 15t\*2, 10t standard counterweight block\*2.

### Crawler Assembly

- Track frame: each track frame is equipped with an independent travel driving device. A hydraulic travel motor drives the planetary gear reducer and realizes independent traveling through the transmission of driving wheel. There are 4-stage speeds: 0.33km/h, 0.55km/h, 0.77km/h, 1.00km/h. The travel system is configured with high and low speeds: sufficient traction is provided in low speed to to travel with 100% load, while faster job-site transfer is possible in high travel speed. Infinite variable speed can be realized in travel driving system;
- Track shoe: it is manufactured by advanced casting techniques and materials with high strength and good wear resistance. After assembled on the machine, the tension can be adjusted by a hydraulic jack with shims used to secure the crawler position.

### Operation Equipments

- All operation equipments adopt high-strength steel tubes and plates; the sheaves at boom tops and hooks are made of milled welded steel.

## Product Specification



### Counterweight

- Counterweight include carbody counterweight, rear counterweight, superlift counterweight and additional rear counterweight, and the details are listed below:

Name	Quantity	Length (m)	Width (m)	Height (m)	Unit Weight (t)
Carbody counterweight tray	2	2.99	2.94	1.06	15
Carbody counterweight block	2	2.85	2.4	0.48	10
Rear counterweight tray	2	3.18	2.83	1.8	10
Rear counterweight block	18	2.85	2.4	0.48	10
Superlift counterweight tray	1	8.6	2.5	4.4	10
Superlift counterweight block	20	2.85	2.4	0.48	10
Additional rear counterweight tray	1	4.12	2.95	1.92	7.15

### Boom

- The boom is a spatial lattice structure with equal section areas for inserts and tapered section areas for both ends. With pipes welded together, and boom tip and root strengthened with steel plates, it can better transfer the load;
- The length of the boom ranges from that (24m) of the base boom to the maximum length (84m) and it can be increased progressively by 6m;
- Composition: boom base 12m×1, transitional insert 10.5m×1, connecting section (boom top) 1.5m×1, boom insert 6m×2, and boom insert 12m×4;
- Optional offers: 3m boom(for wind energy configuration), 72m power boom(12m×5+6m×2);
- The extension jib can install on the boom top.

### Fixed Jib

- The fixed jib is a spatial lattice structure with equal section areas for inserts and tapered section areas for both ends. With pipes welded together, and boom tip and root strengthened with steel plates, it can better transfer the load;
- The length of fixed jib is 12m, and with jib extension.

### Luffing Jib

- The luffing jib is a spatial lattice structure with equal section areas for inserts and tapered section areas for both ends. With pipes welded together, and boom tip and root strengthened with steel plates, it can better transfer the load;
- The length of the luffing jib ranges from 24m to 84m;
- Composition: jib base 10.5m×1, jib insert 6m×3, jib insert 12m×4, and jib top 7.5m×1;
- The extension jib can install on the jib top.

### Superlift Device

- The superlift mast is a spatial lattice structure with equal section areas for inserts and tapered section areas for both ends. With pipes welded together, and boom tip and root strengthened with steel plates, it can better transfer the load;
- The superlift mast is 30m long;
- Composition: mast base 12m×1, insert section 6m×1, insert section 12m×1, and mast top 12m×1.

### Hook

- 6 kinds of hooks are available, and specific parameters are as follows:

Name	Max. Lifting Capacity	Quantity	Pulleys	Unit Weight (t)
650t hook	650t	1	2×13	20.2
350t hook	350t	1	2×7	10.5
180t hook	180t	1	2×3	7.95
160t hook	160t	1	5	3.1
50t hook	50t	1	1	1.7
16t hook	16t	1	-	0.9

#### Note:

The 650t hook, 350t hook and 180t hook can be respectively decomposed to 325t hook, 175t hook and 90t hook.

For shield configuration, 160t hook of a single sheave is available.



## Safety Devices

### Operating Weight

- The operating weight is about 450t, including the upperworks, lowerworks, rear counterweight of basic machine, carbody counterweight, 24m basic boom and 650t hook.

### Ground Bearing Pressure

- The average ground pressure of machine with basic boom is 0.185MPa.

### Gradeability

- The gradeability of machine with basic boom is 15%.

### Load Moment Limiter

- The proprietary load moment limiter independently -developed by Sany is adopted, which forms a network with other controllers through CAN bus line, so as to realize safe and reliable control. The load moment limiter can automatically detect the hoisting weight of the crane and the angle of the boom, and display the rated load capacity, actual load, working radius, and the lifting height of the hook;
- The load moment limiter system consists of a large-screen color display, a host computer, angle sensors, tension sensors, pressure sensors and other components.

### Over-hoist Protection of the Main and Auxiliary Hooks

- It is used to prevent the over-hoist of the hook. When the lifting hook is raised to a certain height, the limit switch will start working, and hook will be automatically cut off from moving up by the control system. Meanwhile, the display and the buzzer will give alarms. At this moment, only hook lowering is allowed to prevent over-hoist action.

### Over-release Protection Device of the Main and Auxiliary Hook

- It is used to prevent the wire rope over-release. When the wire rope is released to the last three wraps, the limit switch will start working, and the releasing of rope will be automatically stopped by the control system. Meanwhile, the display and the buzzer will give alarms. At this moment, only rope retraction is allowed to prevent over release action.

### Assembly/Work Mode Switchover

- In Assembly Mode, some of the safety devices cannot function properly, such as jib lowering limit, boom angle limit in LML, and overload, so as to facilitate the crane assembly;
- In Work Mode, all safety devices can function properly.

### Boom Angle Limit

- When boom angle exceeding 85° and jib angle exceeding 75°, corresponding limit switch will be triggered, and the control system will automatically cut off the boom hoisting. Meanwhile, the display and the buzzer will give alarm. At this moment, boom/jib luffing winch won't hoist but it can still lower down;
- When the boom angle is less than 30° and jib angle less than 15°, the control system will automatically cut off the boom/jib from further lowering. Meanwhile, the display and the buzzer will give alarms. At this moment, boom/jib luffing winch won't be able to lower. This protection is automatically controlled by Load Moment Limiter.

### Back-stop Device

- The boom and the superlift mast are respectively equipped with a pair of back-stop cylinders. The high pressure of the cylinder shall be overcome when the boom tilts backwards, and high pressure oil will be supplemented automatically when the boom swings forwards to increase the tension and prevent the boom vibration and shaking back;
- The jib rear mast is equipped with a pair of back-stop cylinders, while the jib front mast is equipped with a pair of pneumatic cylinders to prevent the mast from the backward inclination and tension of the jib luffing wire rope.

### Brake of Hoisting Mechanism

- All hoisting brakes are spring loaded normally closed disc brakes, which are featured with large braking force, maintenance-free, safe and reliable, and long service life.

### CCTV Monitoring System

- It can be used to monitor the winding conditions of wire ropes of each hoisting mechanism, the conditions of superlift weight, and conditions around the equipment.

## Safety Devices



### Failure Auto-Diagnosis System

- Failure code can help troubleshooting easily.

### Black Box

- It is able to record the operation data and machine movement, and analyze the remaining running conditions and service life of machine based on the actual performance.

### Pharos

- It is mounted on the top of the boom/jib and alerts in air during night.

### Anemometer

- It is mounted on the top of the boom/jib to monitor the wind speed in real time and display relative data on the monitor.

### Electronic Level Indicator

- It displays the tilting angle of the crane on the monitor in real time and protects the safe operation of the crane.

### Lightning Protection Device

- It includes the lightning protection device and the surge protection device, which can effectively protect the electric system elements and workers from lightning.

### Hook Latch

- The lifting hook is installed with a baffle plate to prevent wire rope from falling off.

### Swing and Traveling Alarm

- During swing and traveling, the alarm horn will be blown per certain frequency to alert the personnel around the crane. The horn can be shut off through the display.

### Function Lock

- The operation will be locked by pulling up the function locking lever on the right side of the seat inside the driver's cab or when the operator left the seat, after which no operating handles will be working so that improper operation caused by the body collision when getting on and off the crane can be avoided.

### Regulation of Engine Power Ultimate Load and Stalling Protection

- The controller can monitor the engine power so as to prevent stalling.

### Engine Status Monitoring

- It can show the engine coolant temperature, fuel volume, total working hours, engine oil pressure, engine speed, battery and voltage.

### Remote Monitoring System

- It monitors and analyzes the operation data so as to realize remote diagnosis of faults and timely solution.

### Emergent Stop

- In a sudden loss of control, press the emergent stop, and brakes will be applied on all actions such as hoisting, luffing, swing and traveling and engine stop.





**SCE6000A**  
**SANY CRAWLER CRANE**  
**600 TONS LIFTING CAPACITY**

QUALITY CHANGES THE WORLD

## Technical Parameters

- Page 10 Major Performance & Specifications
- Page 11 Outline Dimension
- Page 13 Transport Dimensions
- Page 21 Transport Plan
- Page 26 Self-Assembly Plan

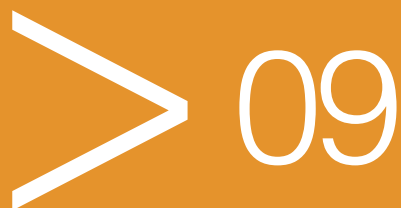

## Major Performance & Specifications

Major Performance & Specifications of SCE6000A		
Performance Indicators	Unit	Parameter
Max. rated lifting capacity	t	600
Max. rated lifting capacity (with superlift)	t	600
Max. rated lifting moment	t·m	3600
Max. rated lifting moment (with superlift)	t·m	7200
Boom length	m	48~84
Boom length (with superlift)	m	48~138
Length of luffing jib	m	24~72
Length of luffing jib (with superlift)	m	24~84
Combination of longest boom+jib (LJDB configuration)	m	84+84
Mixed power boom +fixed jib	m	102+12
Mixed power boom+ fixed jib( with superlift)	m	132+12
Boom hoisting angle	°	30~85
Jib luffing angle	°	25~75
Max. speed of single rope of the main load hoist	m/min	0~140
Max. speed of single rope of the aux.load hoist	m/min	0~140
Max. speed of single rope of the boom hoisting	m/min	(0~70)×2
Max. speed of single rope of the jib luffing	m/min	0~110
Max. speed of single rope of the superlift luffing	m/min	0~110
Slewing speed (no load)	r/min	0~0.86
Travel speed	km/h	0~1(high)/0~0.35(low)
Gradeability (with base boom, driver's cab backwards)	%	15
Rated output power of the engine	kW/r/min	390/2100
Average ground pressure of the crawler (basic boom, 200t rear counterweight, 50t carbody counterweight and 650t hook)	MPa	0.185
Rear counterweight	t	200(without superlift)/160(with superlift)
Superlift counterweight	t	250
Carbody counterweight	t	50
Maximum transport dimensions of single piece (L × W × H)	mm	12100×3000×3200
Maximum transport weight of single piece	t	53
Transport weight of basic machine( with basic boom, 200t rear counterweight, 50t carbody counterweight and 650t hook)	t	450

Unit: mm

### Outline Dimension

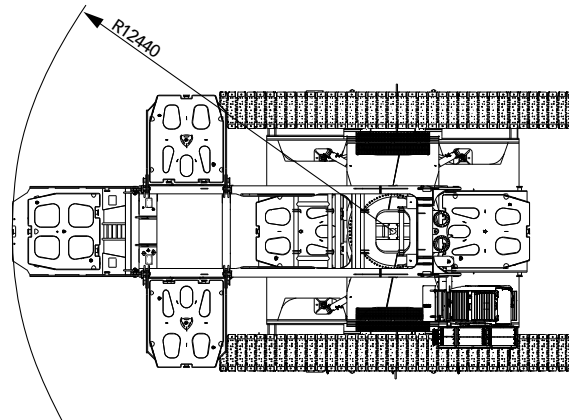
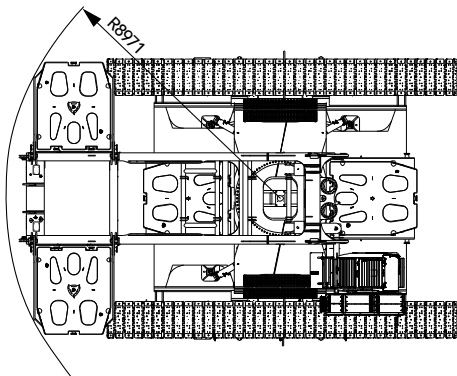
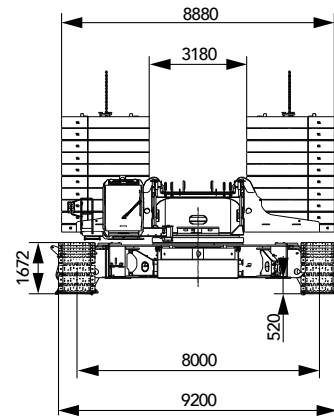
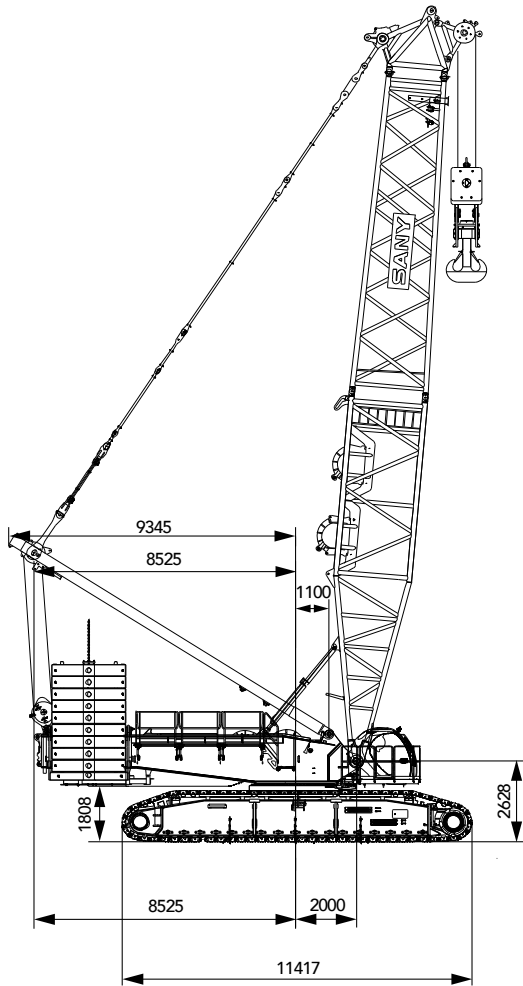

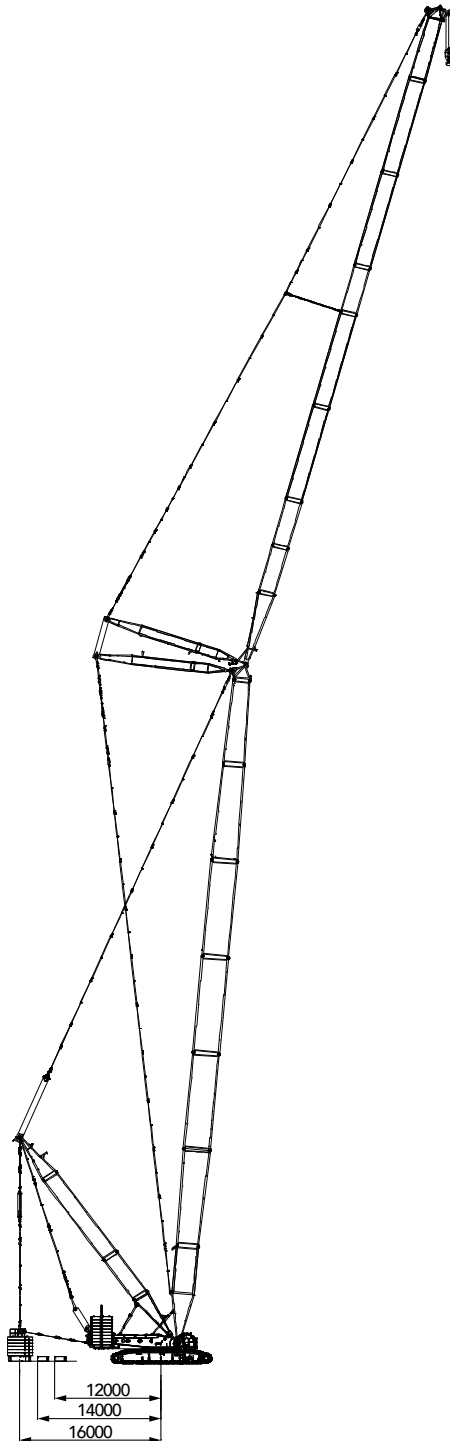
**Outline Dimension**

## Transport Dimensions

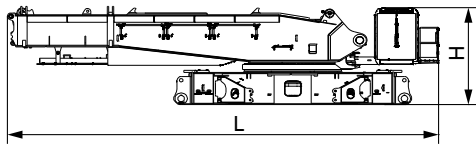

Basic machine	×1
Length (L)	12.90m
Width (W)	3.00m
Height (H)	3.50m
Weight	53.0t

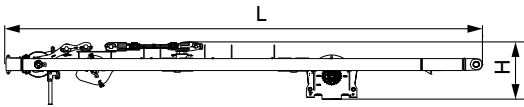

Boom hoisting mast(with winch)	×1
Length (L)	12.30m
Width (W)	2.20m
Height (H)	1.75m
Weight	17.9t

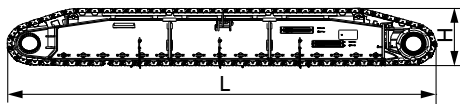

Crawler assembly	×2
Length (L)	11.40m
Width (W)	1.20m
Height (H)	1.67m
Weight	34.8t

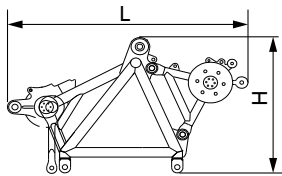

Boom tip(with pulley blocks)	×1
Length (L)	3.85m
Width (W)	2.68m
Height (H)	2.38m
Weight	7.88t

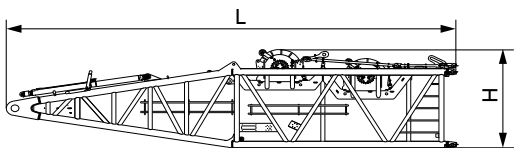

Boom base(with the load hoisting winches)	×1
Length (L)	12.34m
Width (W)	3.00m
Height (H)	3.25m
Weight	26.1t

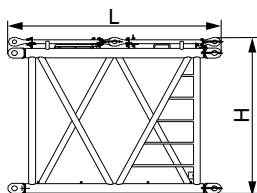

3m boom insert	×1
Length (L)	3.20m
Width (W)	2.98m
Height (H)	2.77m
Weight	1.78t

## Transport Dimensions

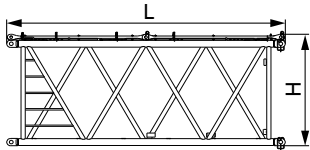

### 6m boom insert

×2

Length(L)	6.20m
Width(W)	3.00m
Height(H)	2.82m
Weight	2.93t

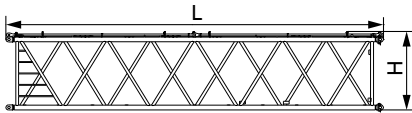

### 12m boom insert A

×1

Length(L)	12.24m
Width(W)	3.00m
Height(H)	2.82m
Weight	5.85t

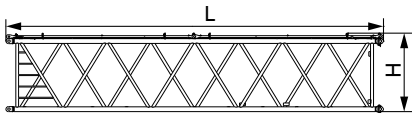

### 12m boom insert B

×2

Length(L)	12.24m
Width(W)	3.00m
Height(H)	2.82m
Weight	5.22t

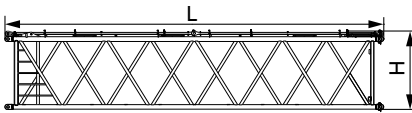

### 12m boom insert C

×1

Length(L)	12.24m
Width(W)	3.00m
Height(H)	2.82m
Weight	5.86t

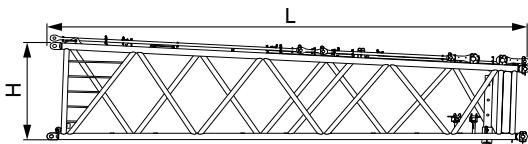

### Tapered boom insert

×1

Length(L)	10.70m
Width(W)	2.98m
Height(H)	2.78m
Weight	7.22t

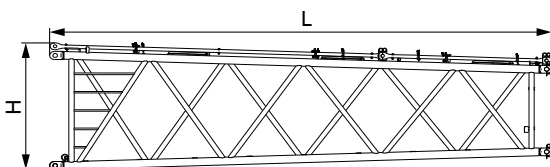

### Tapered insert of mixed boom

×1

Length (L)	9.19m
Width (W)	2.98m
Height (H)	2.78m
Weight	3.55t

## Transport Dimensions

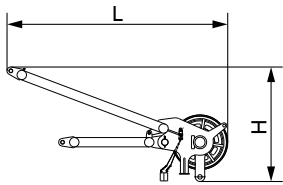

### Extension jib ×1

Length(L)	2.83m
Width(W)	1.70m
Height(H)	1.50m
Weight	0.46t

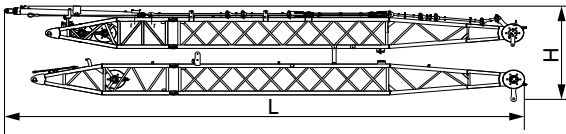

### Front and rear mast of luffing jib ×1

Length(L)	16.80m
Width(W)	3.10m
Height(H)	1.71m
Weight	12.94t

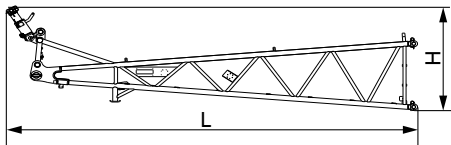

### Luffing jib base ×1

Length(L)	9.71m
Width(W)	2.62m
Height(H)	2.78m
Weight	3.90t

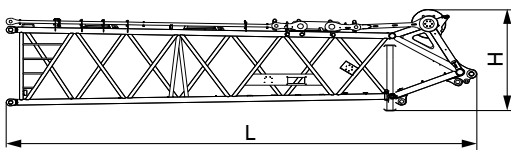

### Luffing jib top ×1

Length(L)	9.75m
Width(W)	2.54m
Height(H)	2.50m
Weight	5.64t

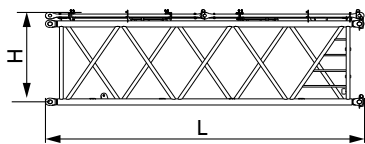

### 6m luffing jib insert A ×2

Length(L)	6.19m
Width(W)	2.54m
Height(H)	2.15m
Weight	2.23t

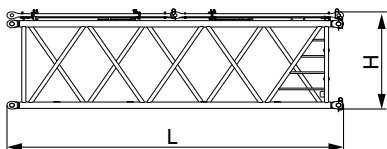

### 6m luffing jib insert B ×1

Length(L)	6.19m
Width(W)	2.54m
Height(H)	2.15m
Weight	2.01t

## Transport Dimensions

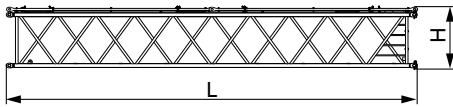

### 12m luffing jib insert A ×2

Length(L)	12.20m
Width(W)	2.54m
Height(H)	2.15m
Weight	3.98t

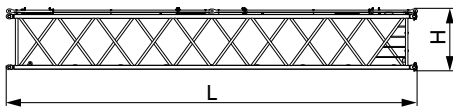

### 12m luffing jib insert B ×2

Length (L)	12.20m
Width (W)	2.54m
Height (H)	2.15m
Weight	3.57t

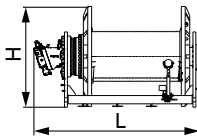

### Jib luffing mechanism ×1

Length(L)	1.72m
Width(W)	1.34m
Height(H)	1.23m
Weight	5.09t

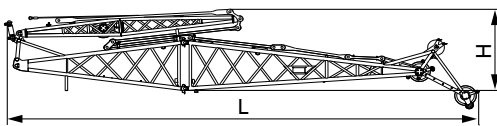

### Fixed jib assembly ×1

Length(L)	14.00m
Width(W)	2.40m
Height(H)	3.25m
Weight	5.11t

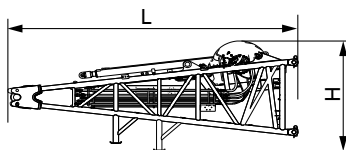

### Superlift mast base ( with superlift luffing winch) ×1

Length(L)	6.30m
Width(W)	2.61m
Height(H)	2.84m
Weight	10.0t

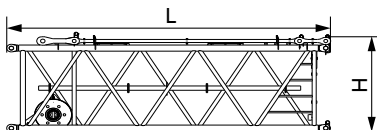

### 6m superlift mast insert ×1

Length (L)	6.21m
Width (W)	2.96m
Height (H)	2.14m
Weight	2.90t



## Transport Dimensions

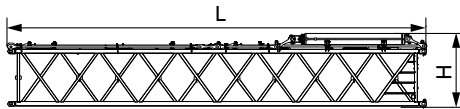

### 12m superlift mast insert ×1

Length(L)	12.21m
Width(W)	3.02m
Height(H)	2.60m
Weight	8.65t

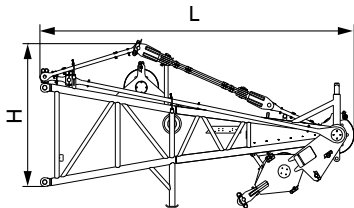

### Superlift mast top ×1

Length(L)	6.45m
Width(W)	2.96m
Height(H)	2.76m
Weight	7.78t

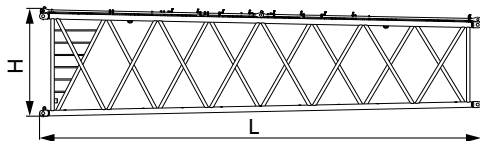

### 12m power boom lower transition insert ×1

Length(L)	12.20m
Width(W)	3.56m
Height(H)	3.25m
Weight	8.09t

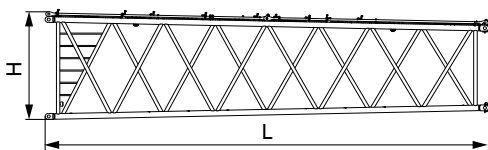

### 12m power boom upper transition insert ×1

Length(L)	12.20m
Width(W)	3.56m
Height(H)	3.25m
Weight	6.53t

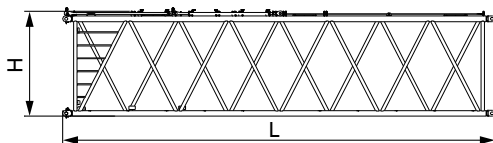

### 12m power boom insert A ×1

Length(L)	12.20m
Width(W)	3.56m
Height(H)	3.25m
Weight	6.68t

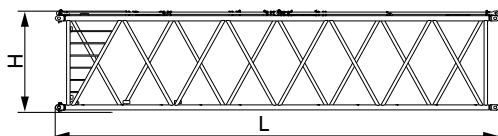

### 12m power boom insert B ×2

Length(L)	12.20m
Width(W)	3.56m
Height(H)	3.25m
Weight	7.09t

## Transport Dimensions

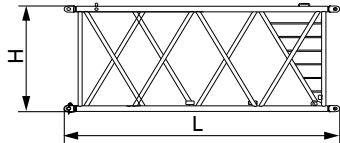

### 6m power boom insert ×2

Length(L)	6.20m
Width(W)	3.56m
Height(H)	3.25m
Weight	3.67t

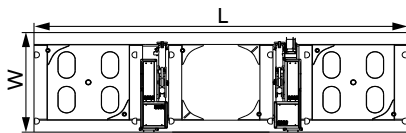

### Superlift counterweight tray ×1

Length(L)	8.60m
Width(W)	2.50m
Height(H)	1.85m
Weight	10.0t

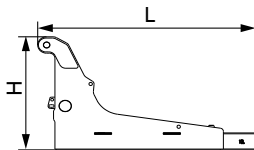

### Rear counterweight tray ×2

Length(L)	3.18m
Width(W)	2.83m
Height(H)	1.80m
Weight	10.0t

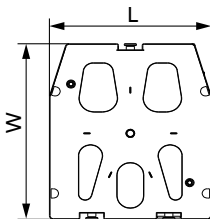

### 10t counterweight block ×40

Length(L)	2.40m
Width(W)	2.85m
Height(H)	0.48m
Weight	10.0t

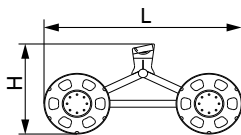

### Trolley ×1

Length(L)	3.00m
Width(W)	2.05m
Height(H)	1.50m
Weight	1.09t

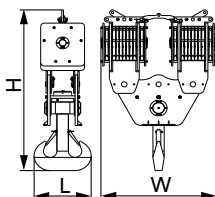

### 650t hook ×1

Length(L)	1.685m
Width(W)	3.60m
Height(H)	4.84m
Weight	20.17t

## Transport Dimensions

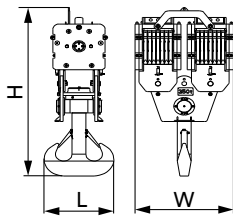

### 350t hook ×1

Length(L)	1.00m
Width(W)	1.88m
Height(H)	3.84m
Weight	10.34t

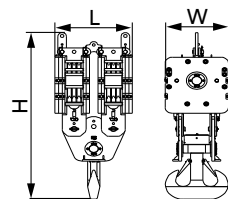

### 180t hook ×1

Length(L)	1.31m
Width(W)	1.07m
Height(H)	3.06m
Weight	7.95t

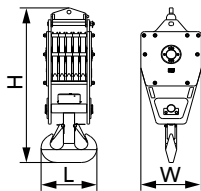

### 160t hook ×1

Length(L)	0.60m
Width(W)	1.02m
Height(H)	2.64m
Weight	3.12t

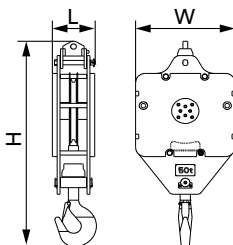

### 50t hook ×1

Length(L)	0.45m
Width(W)	1.02m
Height(H)	2.30m
Weight	1.69t

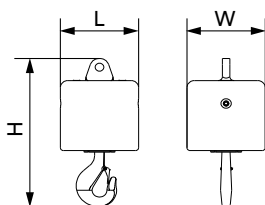

### 16t hook ×1

Length(L)	0.53m
Width(W)	0.53m
Height(H)	1.10m
Weight	0.94t

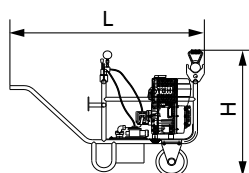

### Portable power pack ×1

Length(L)	1.55m
Width(W)	0.70m
Height(H)	1.09m
Weight	0.20t

## Transport Dimensions

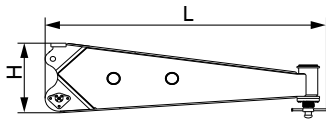

### Side outrigger

×2

Length(L)	3.62m
Width(W)	0.80m
Height(H)	0.98m
Weight	1.19t

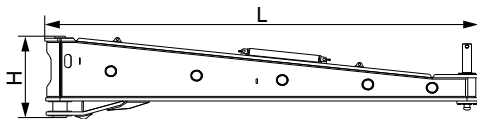

### Front outrigger

×2

Length(L)	6.08m
Width(W)	0.60m
Height(H)	0.98m
Weight	3.25t

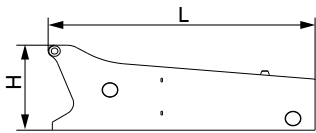

### Carbody counterweight tray

×2

Length(L)	3.03m
Width(W)	2.94m
Height(H)	1.05m
Weight	15.0t

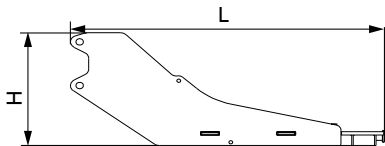

### Additional rear counterweight tray

×1

Length(L)	4.12m
Width(W)	2.95m
Height(H)	1.92m
Weight	7.15t

#### Note:

1. The transport dimensions of each part in the table are schematic, not proportional to the real parts. The dimensions are designed value without package considered.
2. Weight is designed value that the actual manufactured part may deviate a little.
3. The dimensions and weight of each part may change due to product upgrading. The final values are subject to the new product.

## Transport Plan

Trailer 1	
Transport weight	▪ 53t
Part	▪ Rotating bed ▪ Carbody
Truckload	▪ 1+1

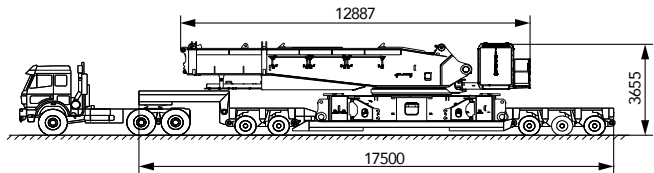

Trailer 2	
Transport weight	▪ 34.8t
Part	▪ Crawler assembly
Truckload	▪ 1

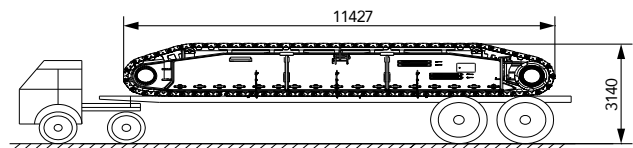

Trailer 3	
Transport weight	▪ 34.8t
Part	▪ Crawler assembly
Truckload	▪ 1

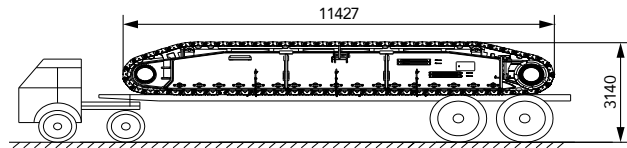

Trailer 4	
Transport weight	▪ 36.1t
Part	▪ Boom base ▪ 10t counterweight block
Truckload	▪ 1+1

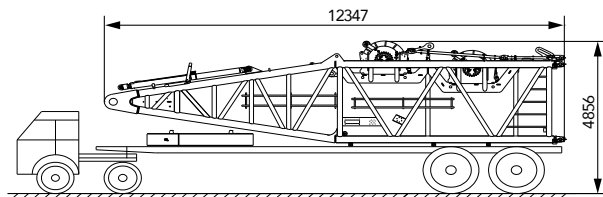

Trailer 5	
Transport weight	▪ 31.43t
Part	▪ Tapered boom insert ▪ Carbody counterweight tray ▪ 10t counterweight block
Truckload	▪ 1+1+1

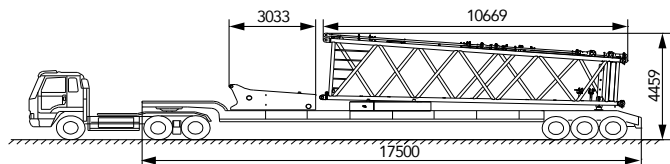

Trailer 6.7	
Transport weight	▪ 35.88t
Part	▪ 12m boom insert B ▪ 12m luffing jib insert B ▪ 12m power boom insert B ▪ 10t counterweight block
Truckload	▪ 1+1+1+2

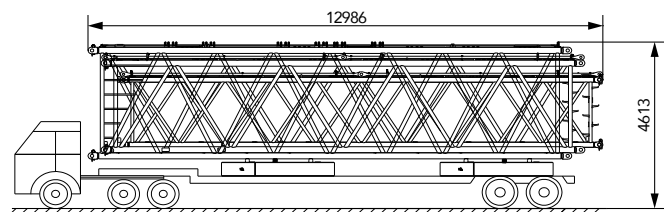

## Transport Plan

Trailer 8	
Transport weight	▪ 36.51t
Part	<ul style="list-style-type: none"> <li>▪ 12m boom insert A</li> <li>▪ 12m luffing jib insert A</li> <li>▪ 12m power boom insert A</li> <li>▪ 10t counterweight block</li> </ul>
Truckload	▪ 1+1+1+2

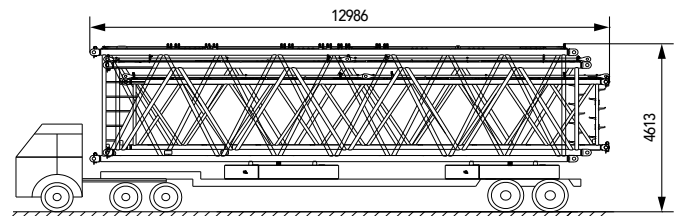

Trailer 9	
Transport weight	▪ 29.842t
Part	<ul style="list-style-type: none"> <li>▪ 12m boom insert C</li> <li>▪ 12m luffing jib insert A</li> <li>▪ 10t counterweight block</li> </ul>
Truckload	▪ 1+1+2

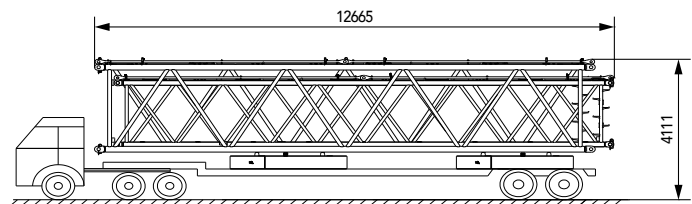

Trailer 10	
Transport weight	▪ 28.04t
Part	<ul style="list-style-type: none"> <li>▪ 6m boom insert</li> <li>▪ 6m luffing jib insert A</li> <li>▪ Boom tip</li> <li>▪ Pulley block</li> <li>▪ Carbody counterweight tray</li> </ul>
Truckload	▪ 1+1+1+2+1

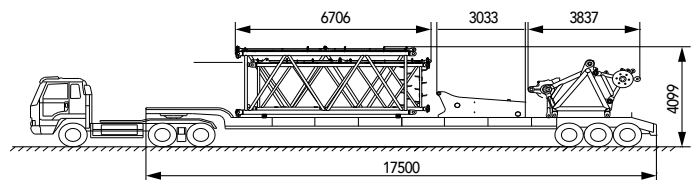

Trailer 11	
Transport weight	▪ 28.66t
Part	<ul style="list-style-type: none"> <li>▪ 6m boom insert</li> <li>▪ 6m luffing jib insert A</li> <li>▪ 10t counterweight block</li> <li>▪ 6m power boom insert</li> </ul>
Truckload	▪ 1+1+1+2

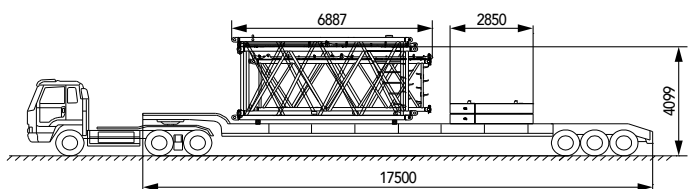

Trailer 12	
Transport weight	▪ 27.9t
Part	<ul style="list-style-type: none"> <li>▪ Boom hoisting mast and winch</li> <li>▪ 10t counterweight block</li> </ul>
Truckload	▪ 1+1

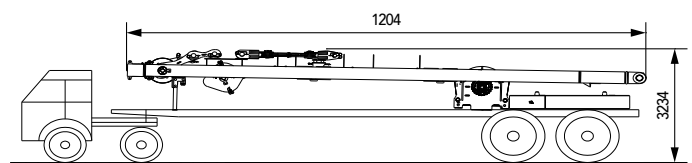

Trailer 13	
Transport weight	▪ 30.93t
Part	<ul style="list-style-type: none"> <li>▪ Jib top</li> <li>▪ Portable power pack</li> <li>▪ Jib luffing mechanism</li> <li>▪ 10t counterweight block</li> </ul>
Truckload	▪ 1+1+1+2

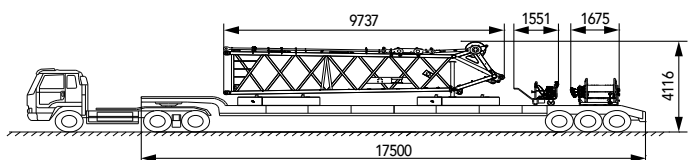

## Transport Plan

Trailer 14	
Transport weight	▪ 23.9t
Part	▪ Luffing jib base ▪ 10t counterweight block
Truckload	▪ 1+2

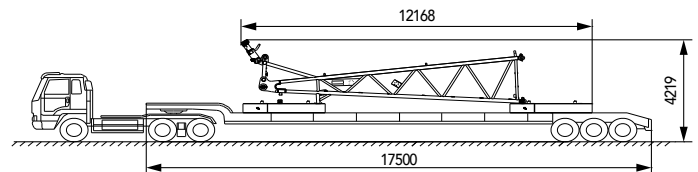

Trailer 15	
Transport weight	▪ 30.94t
Part	▪ Front and rear mast of luffing jib ▪ 10t counterweight block
Truckload	▪ 1+1+2

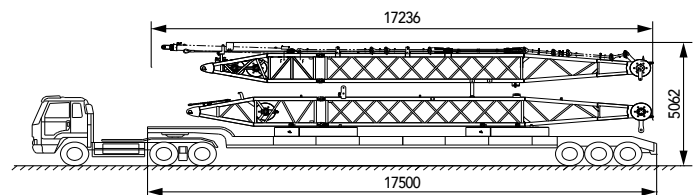

Trailer 16	
Transport weight	▪ 28.38t
Part	▪ 6m power boom insert ▪ 6m luffing jib insert B ▪ Trolley ▪ 3m boom insert ▪ 10t counterweight block
Truckload	▪ 1+1+1+1+2

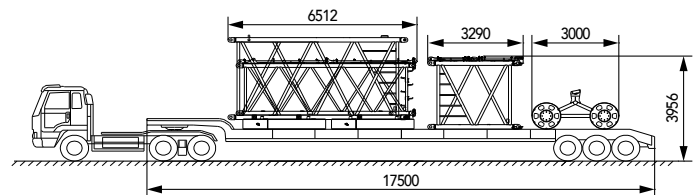

Trailer 17	
Transport weight	▪ 29.79t
Part	▪ Superlift mast top ▪ 10t counterweight block ▪ 6m luffing jib insert B
Truckload	▪ 1+2+1

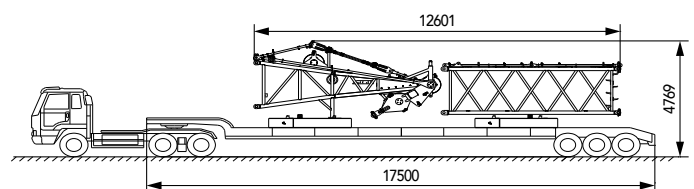

Trailer 18	
Transport weight	▪ 32.90t
Part	▪ Superlift mast base and luffing mechanism ▪ 10t counterweight block ▪ 6m superlift mast insert
Truckload	▪ 1+2+1

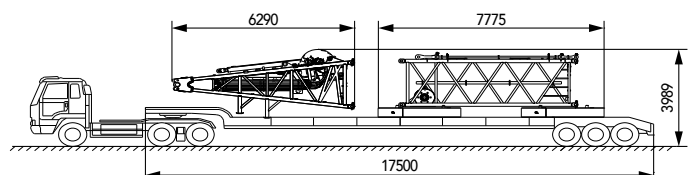

Trailer 19	
Transport weight	▪ 30.01t
Part	▪ Superlift mast top ▪ Package case ▪ 10t counterweight block
Truckload	▪ 1+2+2

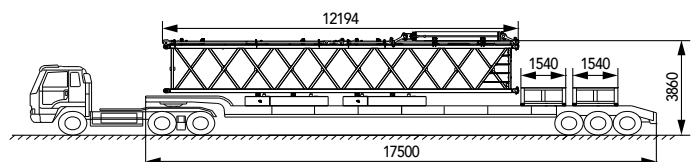

## Transport Plan

Trailer 20	
Transport weight	▪ 25.28t
Part	▪ Fixed jib assembly ▪ 10t counterweight block
Truckload	▪ 1+2

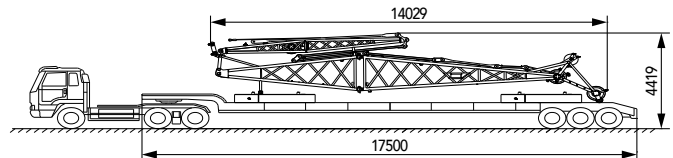

Trailer 21	
Transport weight	▪ 30t
Part	▪ Superlift counterweight tray ▪ 10t counterweight block
Truckload	▪ 1+2

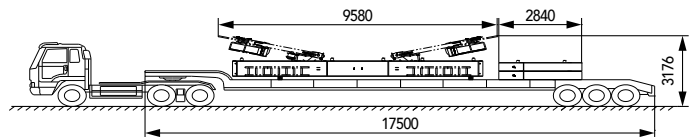

Trailer 22	
Transport weight	▪ 20t
Part	▪ 10t counterweight block
Truckload	▪ 2

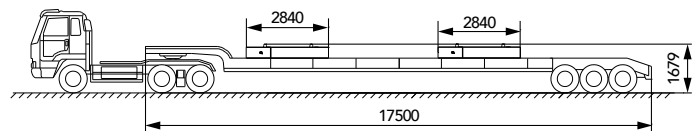

Trailer 23	
Transport weight	▪ 28.09t
Part	▪ 12m lower transition insert ▪ Rear counterweight tray ▪ 10t counterweight block
Truckload	▪ 1+1+1

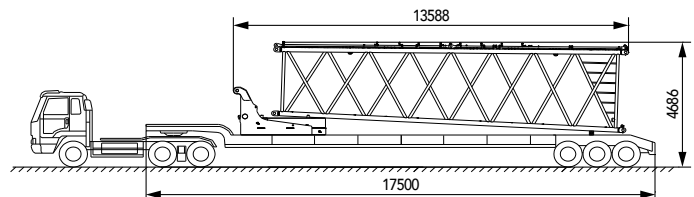

Trailer 24	
Transport weight	▪ 26.59t
Part	▪ 12m upper transition insert ▪ Rear counterweight tray ▪ 10t counterweight block
Truckload	▪ 1+1+1

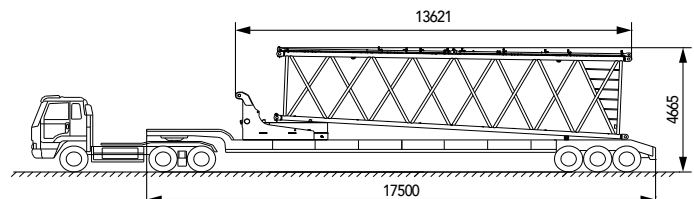

Trailer 25	
Transport weight	▪ 23.55t
Part	▪ Tapered insert of mixed boom ▪ 10t counterweight block
Truckload	▪ 1+2

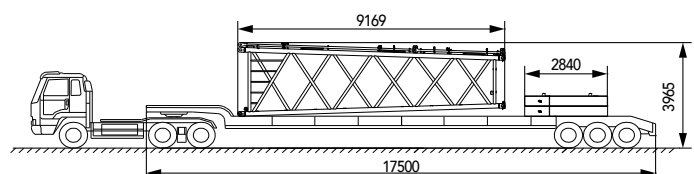



## Transport Plan

Trailer 26	
Transport weight	▪ 29.53
Part	<ul style="list-style-type: none"> <li>▪ Side outrigger</li> <li>▪ Additional rear counterweight tray</li> <li>▪ 10t counterweight block</li> </ul>
Truckload	▪ 2+1+2

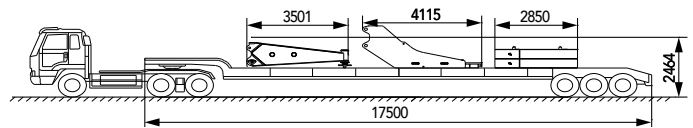

Trailer 27	
Transport weight	▪ 30.46t
Part	<ul style="list-style-type: none"> <li>▪ Extension jib</li> <li>▪ 10t counterweight block</li> </ul>
Truckload	▪ 1+3

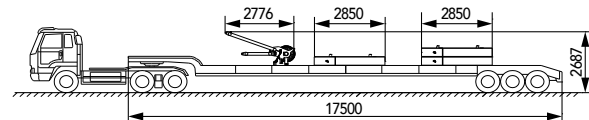

Trailer 28	
Transport weight	▪ 35.07t
Part	<ul style="list-style-type: none"> <li>▪ 16t ball hook</li> <li>▪ 50t hook</li> <li>▪ 160t hook</li> <li>▪ 180t hook</li> <li>▪ 350t hook</li> <li>▪ 650t hook</li> </ul>
Truckload	▪ 1+1+1+1+1+1

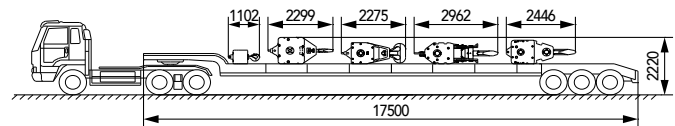

## Self-Assembly Plan

### Crawler frame self-assembly

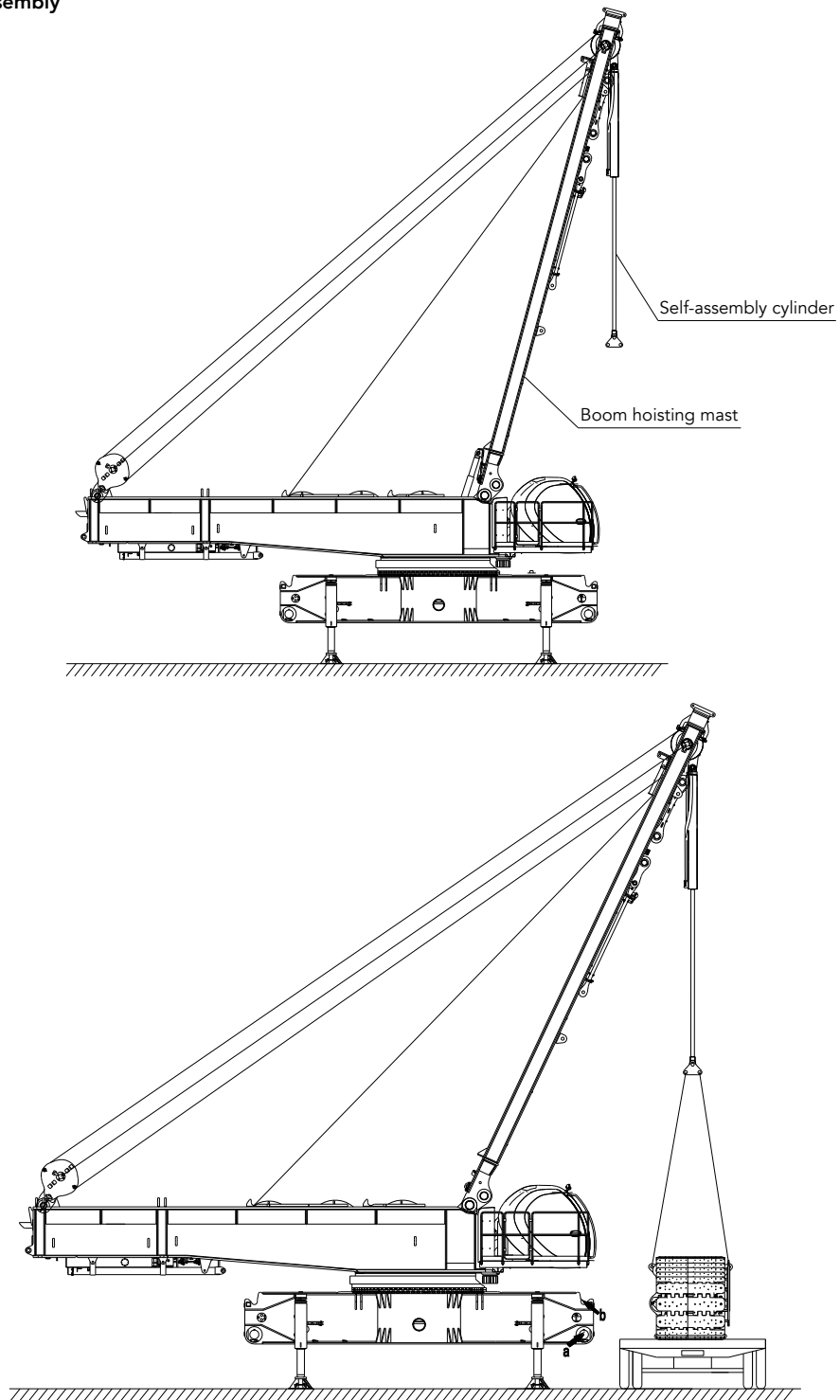



# **SCE6000A SANY CRAWLER CRANE 600 TONS LIFTING CAPACITY**

QUALITY CHANGES THE WORLD

## Cofigurations

- Page 28 Configuration
- Page 32 H Configuration
- Page 35 HDB Configuration
- Page 38 HJ Configuration
- Page 41 HJDB Configuration
- Page 44 HJFJ\_3 Configuration
- Page 48 HJFJDB\_6 Configuration
- Page 52 LJ(DB) Configuration
- Page 59 LJDB Configuration
- Page 69 ZH Configuration
- Page 72 ZHDB Configuration
- page 75 ZLJ Configuration
- page 80 ZLJDB Configuration
- page 89 FJh Configuration
- page 93 FJhDB Configuration



## Configurations

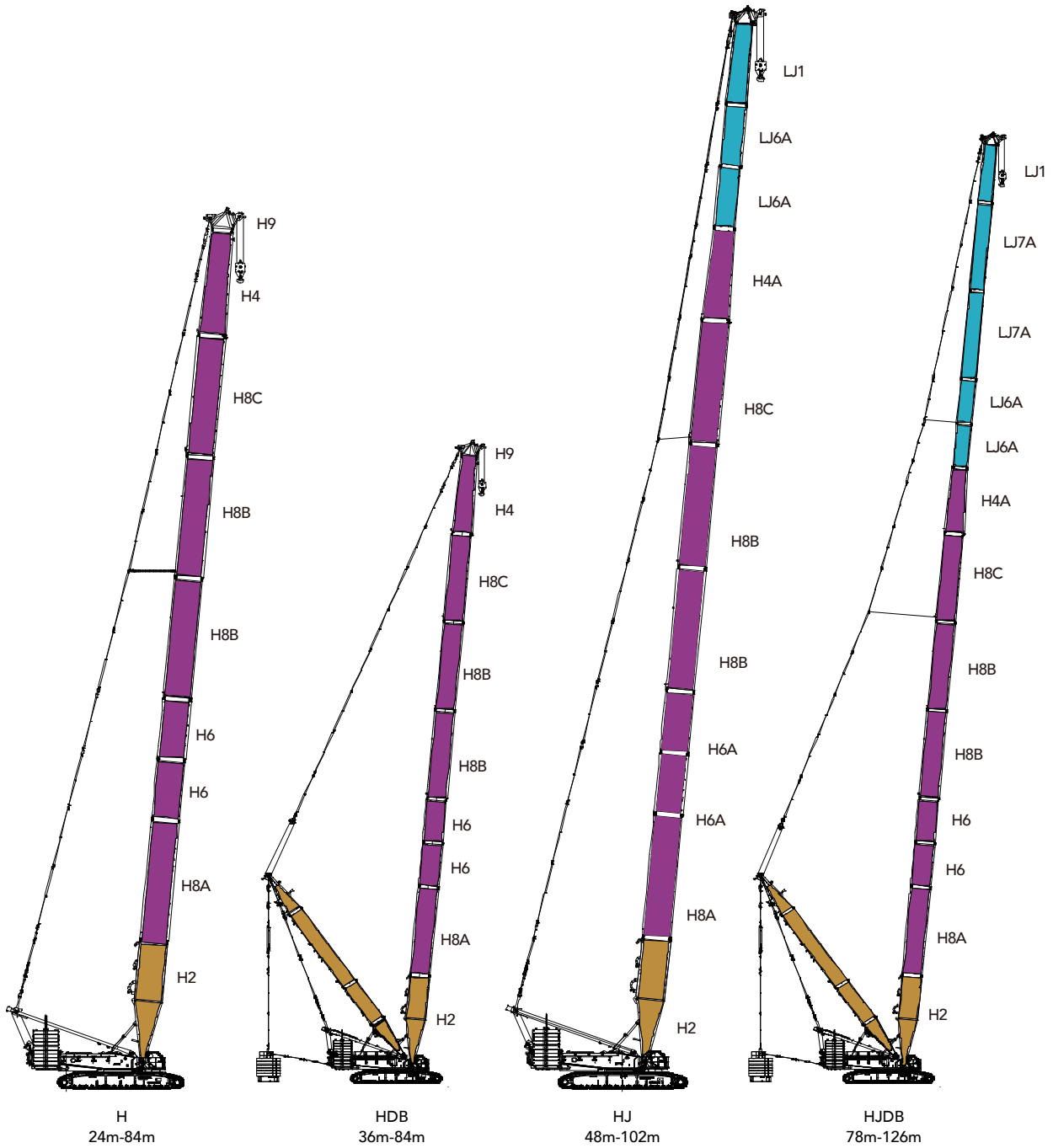

Configuration	Boom Combination	Boom Length
H	Boom	24m-84m
HDB	Boom+Superlift mast+Sperlift counterweight	36m-84m
HJ	Mixed boom	48m-102m
HJDB	Mixed boom+ superlift mast +superlift counterweight	78m-126m

Note: The schematics above are reference for loading only.

## Configurations

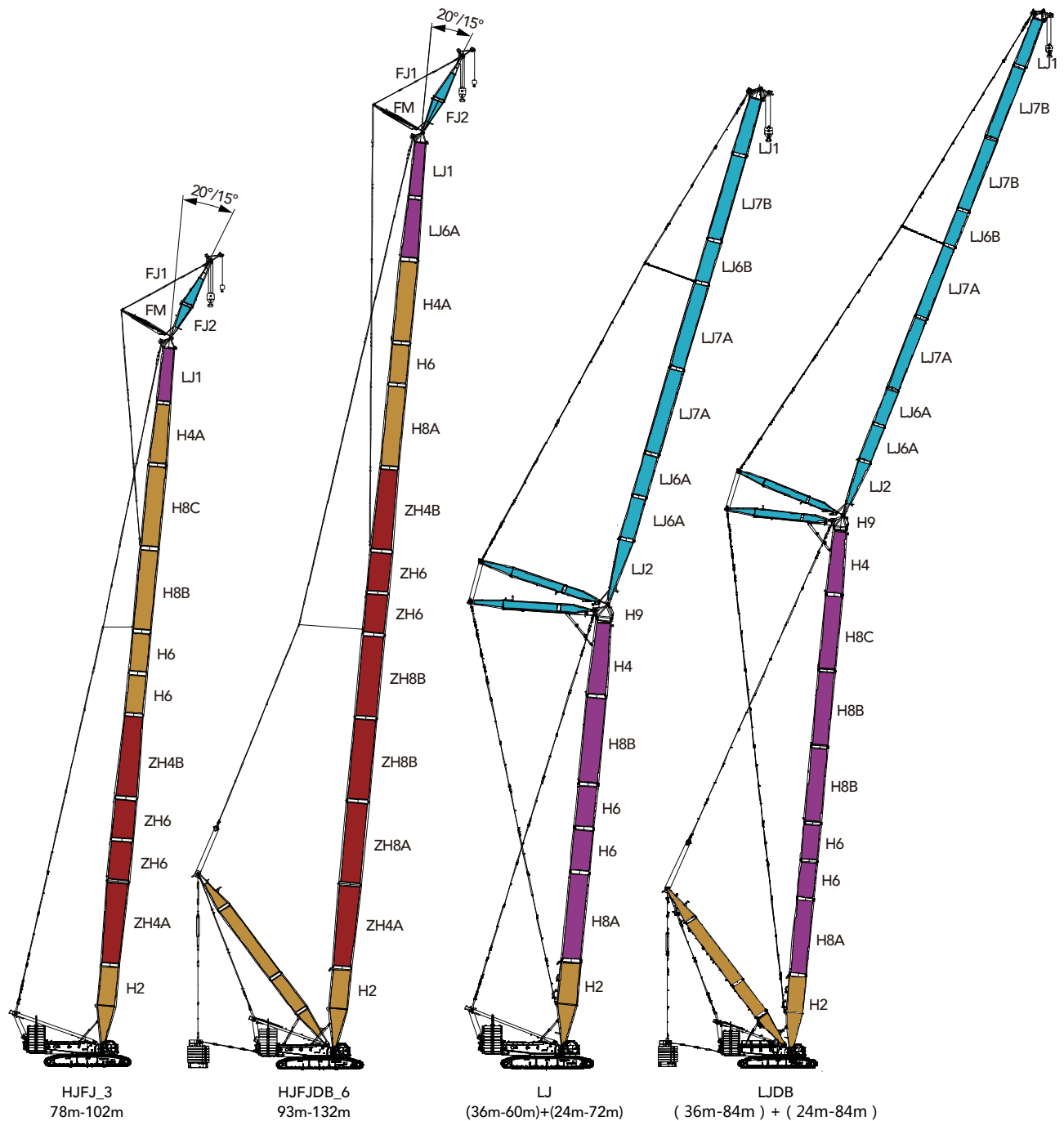

Configuration	Boom Combination	Boom Length
HJFJ_3	Power boom+boom+fixed jib	78m-102m
HJFJDB_6	Power boom+boom+fixed jib+superlift mast+superlift counterweight	93m-132m
LJ	Boom+Luffing jib	( 36m-60m ) + ( 24m-72m )
LJDB	Boom+Luffing jib+Superlift counterweight	( 36m-84m ) + ( 24m-84m )

Note: The schematics above are reference for loading only.

## Configurations

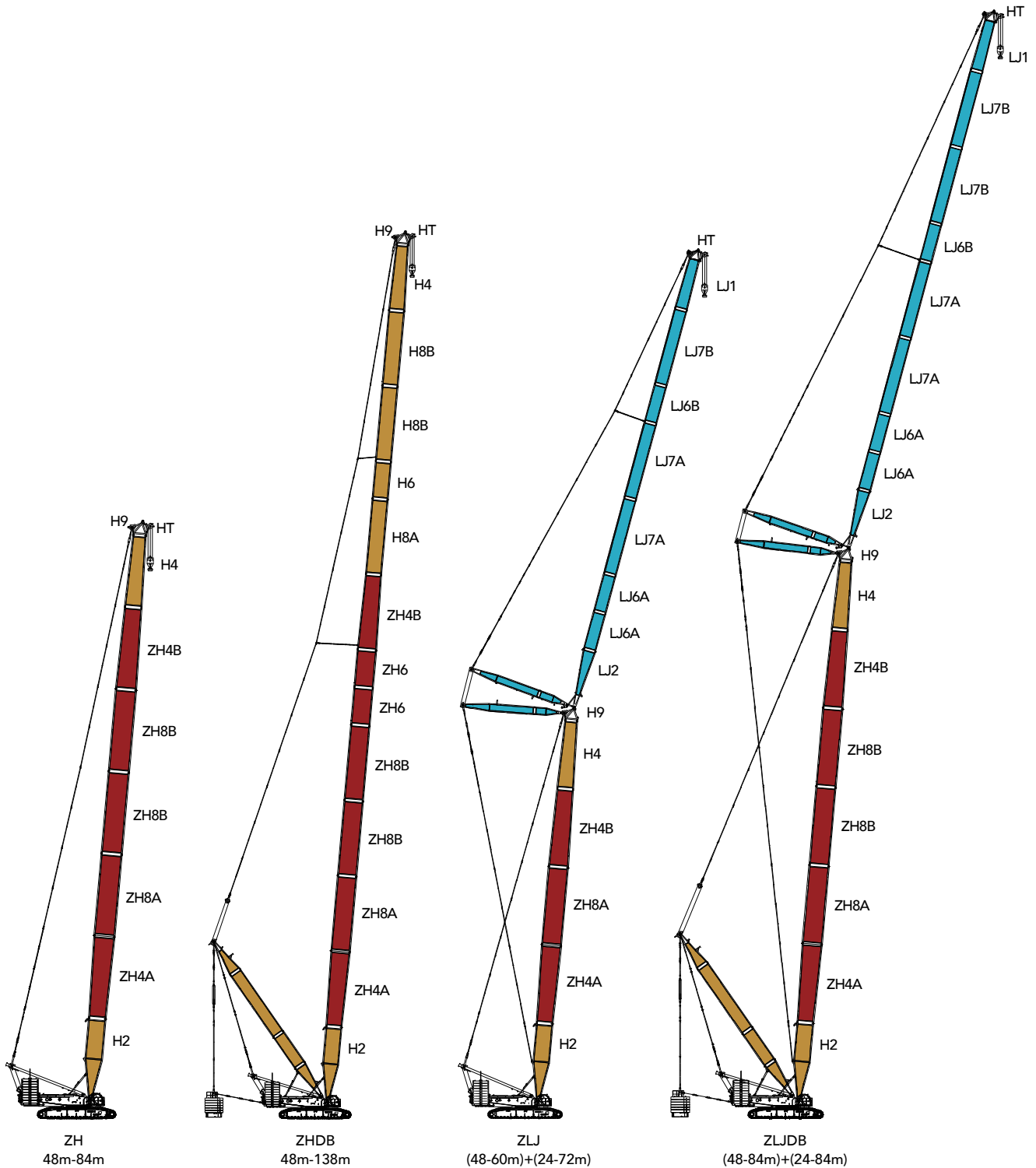

Configuration	Boom Combination	Boom Length
ZH	Power boom+boom	48m-84m
ZHDB	Power boom+boom+superlift mast+superlift counterweight	48m-138m
ZLJ	Power boom+boom+luffing jib	( 48m-60m ) + ( 24m-72m )
ZLJDB	Power boom+boom+luffing jib+superlift mast+superlift counterweight	( 48m-84m ) + ( 24m-84m )

Note: The schematics above are reference for loading only.

## Configurations

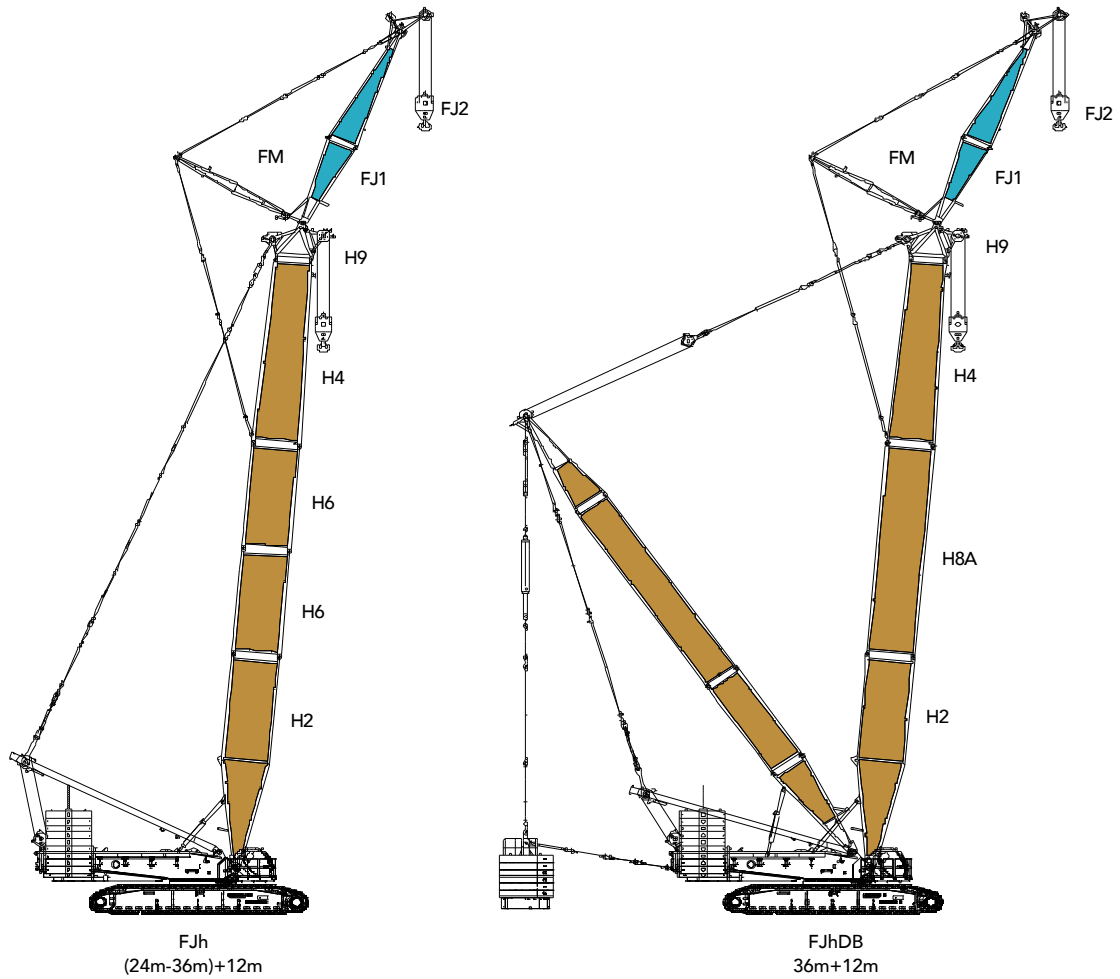

Configuration	Boom Combination	Boom Length
FJh	Boom+fixed jib	( 24m-36m ) +12m
FJhDB	Boom+fixed jib+superlift mast+superlift counterweight	36m+12m

Note: The schematics above are reference for loading only.

## Boom Combination in H

Boom Combination in H				
Boom length (m)	boom insert			
	6m/(H6)	12mA/(H8A)	12mA/(H8B)	12mA/(H8C)
24	-	-	-	-
30	1	-	-	-
36	2	-	-	-
42	1	1	-	-
48	2	1	-	-
54	1	1	1	-
60	2	1	1	-
66	1	1	2	-
72	2	1	2	-
78*	1	1	2	1
84*	2	1	2	1

Note: For combinations of 78m and 84m, marked with "\*", the mid-point suspension cable must be used, otherwise, the boom system may break.  
Attention: If the boom length is 78m and more, the crane must boom up from side by side erection outrigger, otherwise, the crane may tip over!

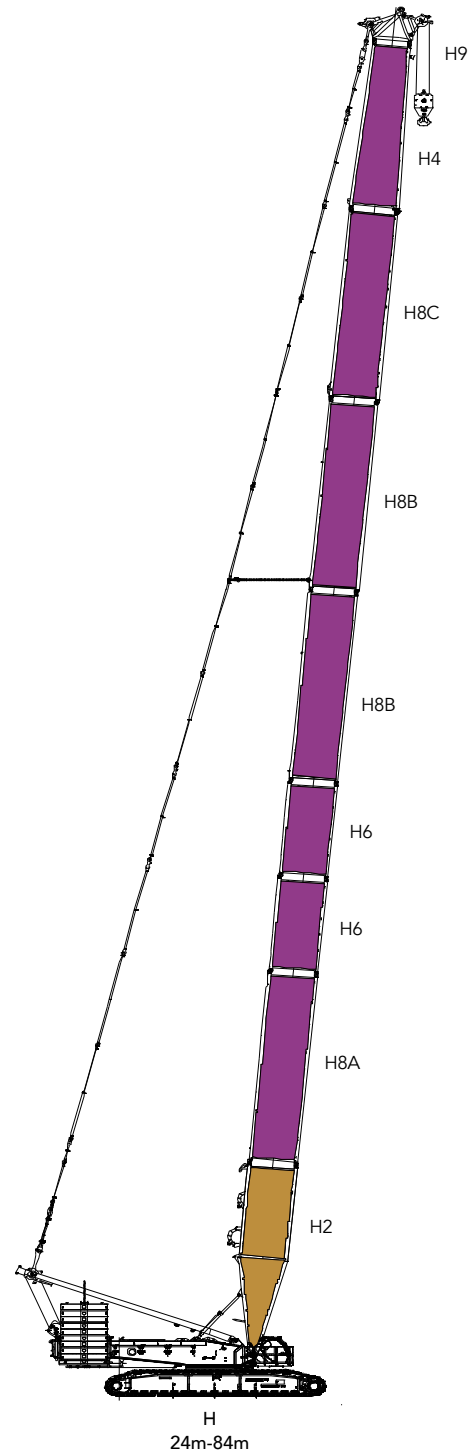



## Working Radius in H

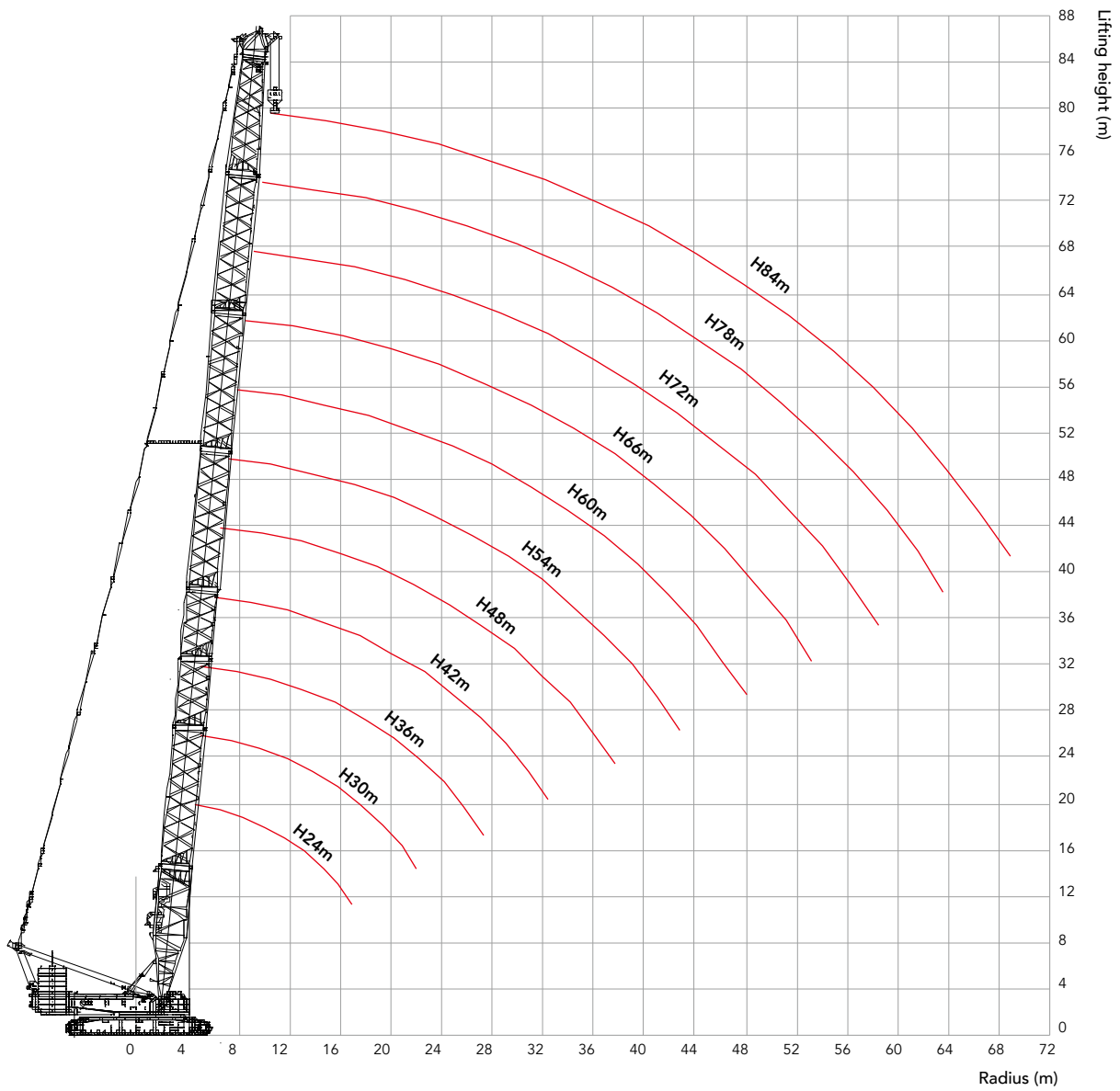

**Load Chart of H**

SCE6000A Crawler Crane—H Configuration												
Boom length 24~84m, Rear counterweight 200t, Carbody counterweight 50t												
Boom length Radius(m)	24	30	36	42	48	54	60	66	72	78	84	Boom length Radius(m)
6	600											6
7	564	524	475									7
8	509	473	442	414	389							8
9	430	404	381	359	340	323	306					9
10	372	352	334	317	301	287	274	262	250			10
11	327	311	297	283	270	258	247	237	227	218	209	11
12	291	279	266	255	244	235	225	216	208	200	192	12
14	231	229	221	212	204	197	190	183	177	170	164	14
16	188	189	188	181	175	169	163	158	153	147	142	16
18	158	159	159	157	152	148	143	138	134	129	125	18
20	135	136	137	137	134	130	126	122	119	115	111	20
22	117	118	119	119	119	116	113	109	106	102	99.5	22
24		104	105	105	104	104	101	98.8	95.7	92.5	89.5	24
26		92.8	93.4	93.4	93.1	93.0	92.0	89.4	86.6	83.7	81.0	26
28		82.9	83.7	83.7	83.4	83.3	82.7	81.4	78.8	76.1	73.5	28
30			75.4	75.5	75.2	75.1	74.4	74.0	72.0	69.4	67.1	30
32			68.3	68.4	68.2	68.0	67.4	67.0	66.0	63.6	61.3	32
34				62.3	62.1	61.9	61.3	60.8	60.1	58.4	56.3	34
36				56.9	56.7	56.5	55.9	55.5	54.7	53.7	51.7	36
38				52.1	51.9	51.8	51.2	50.7	50.0	49.0	47.6	38
40					47.7	47.6	47.0	46.5	45.8	44.8	43.9	40
44					40.4	40.4	39.8	39.4	38.6	37.6	36.7	44
48						34.4	33.9	33.5	32.7	31.7	30.8	48
52							28.9	28.5	27.8	26.8	25.9	52
56								24.3	23.6	22.6	21.7	56
60									20.0	19.0	18.1	60
64									16.8	15.9	15.0	64
68										13.1	12.2	68
72											9.8	72

## Boom Combination in HDB

Boom Combination in HDB				
Boom length (m)	boom insert			
	6m/ (H6)	12mA/ (H8A)	12mB/ (H8B)	12mC/ (H8C)
36	-	1	-	-
42	1	1	-	-
48	2	1	-	-
54	1	1	1	-
60	2	1	1	-
66	1	1	2	-
72	2	1	2	-
78	1	1	2	1
84	2	1	2	1

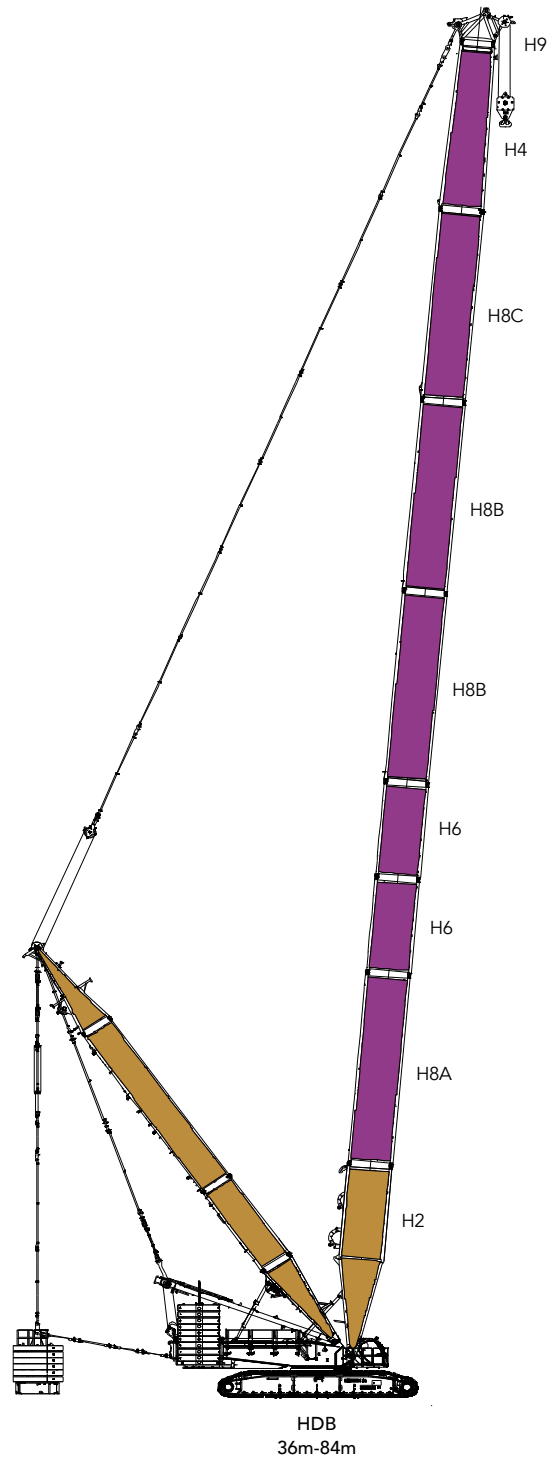

## Working Radius in HDB

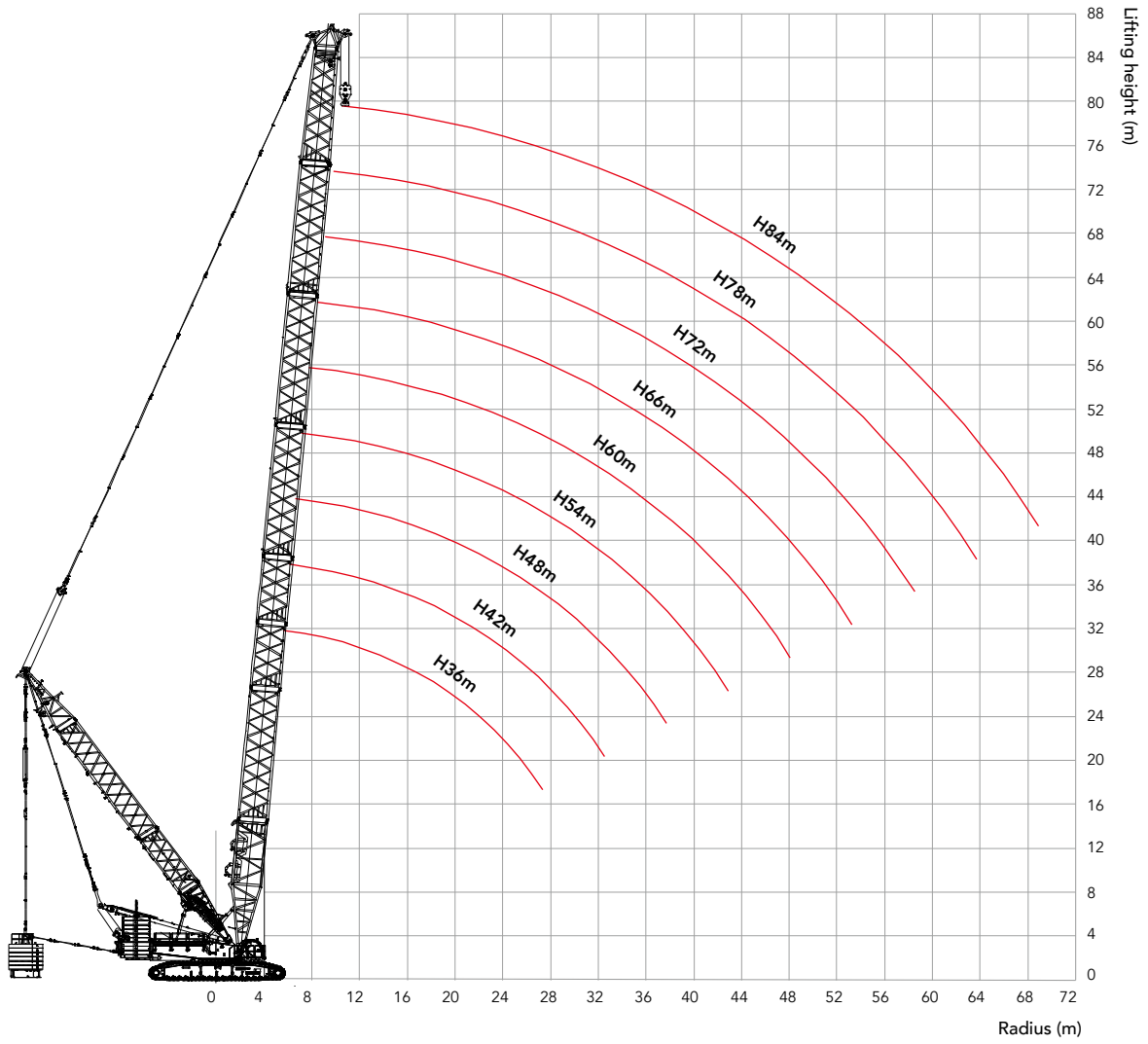

Unit: t

## Load Chart of HDB

SCE6000A Crawler Crane—HDB Configuration										
Boom length 36~84m, Superlift radius 16m, Superlift counterweight 250t, Rear counterweight 160t, Carbody counterweight 50t										
Boom length Radius(m)	36	42	48	54	60	66	72	78	84	Boom length Radius(m)
7	534*									7
8	534*	480*	451*							8
9	538*	478*	450*	410*	388*					9
10	538*	481*	452*	409*	388*	347*	314*			10
11	540	480*	454*	411*	388*	347*	316*	263*	220*	11
12	545	483	453	411*	388*	349*	316*	262*	221*	12
14	552	486	455	413	390	350*	316*	263*	221*	14
16	487	487	460	416	391	350	317	263*	222*	16
18	427	427	426	419	394	353	317	263*	221*	18
20	380	380	379	379	370	355	316	263	221*	20
22	339	340	339	339	335	328	315	262	220	22
24	303	303	303	303	303	299	293	262	220	24
26	273	273	273	273	273	273	269	262	219	26
28	248	248	248	248	248	248	247	244	216	28
30	227	227	227	227	227	227	226	225	214	30
32	209	209	209	209	209	208	208	207	206	32
34		194	193	193	193	193	192	192	191	34
36		180	180	180	179	179	179	178	177	36
38		168	168	168	167	167	166	166	165	38
40			157	157	157	156	156	155	154	40
44			139	139	138	138	137	137	136	44
48				124	123	123	123	122	121	48
52					111	111	110	109	108	52
56						100	99.9	99.0	98.3	56
60							90.8	89.9	89.2	60
64							82.8	82.0	81.3	64
68								75.1	74.3	68
72									68.2	72

Note: For values above with “\*”, the superlift counterweight must not leave the ground.

## Boom Combination in HJ

### Boom Combination in HJ

Boom length (m)	Boom insert				Jib insert
	6m/ (H6)	12mA/ (H8A)	12mB/ (H8B)	12mC/ (H8C)	6m/ (LJ6A)
48	1	1	-	-	-
54	2	1	-	-	-
60	1	1	1	-	-
66	2	1	1	-	-
72	1	1	2	-	-
78*	2	1	2	-	-
84*	1	1	2	1	-
90*	2	1	2	1	-
96*	2	1	2	1	1
102*	2	1	2	1	2

Note: For combinations of 78m and more, marked with "\*", the mid-point suspension cable must be used, otherwise, the boom system may break.  
Attention: If the boom length is 84m and more, the crane must boom up from side by side erection outrigger, otherwise, the crane may tip over!

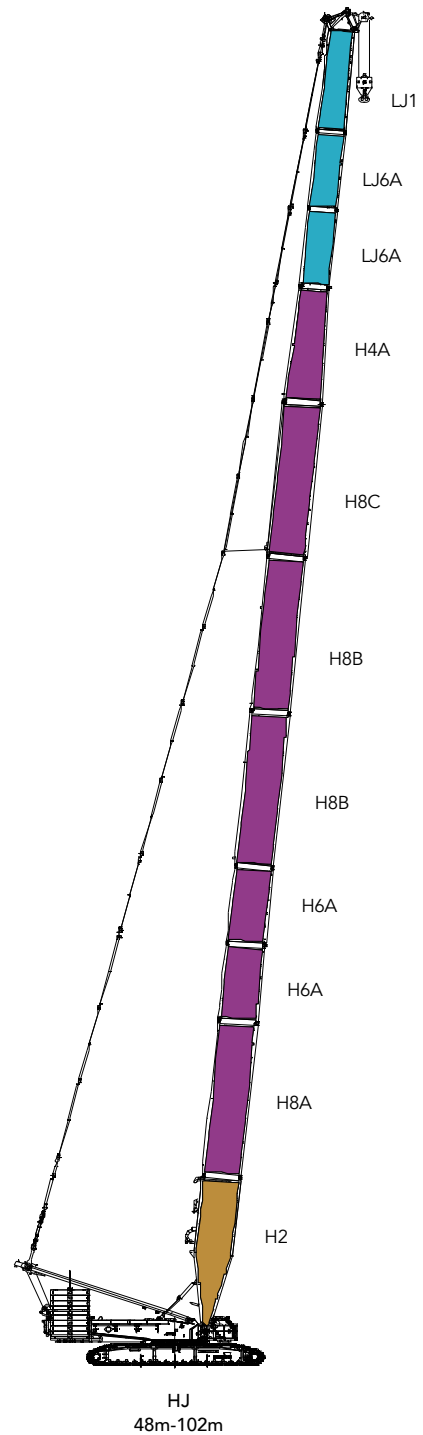

## Working Radius in HJ

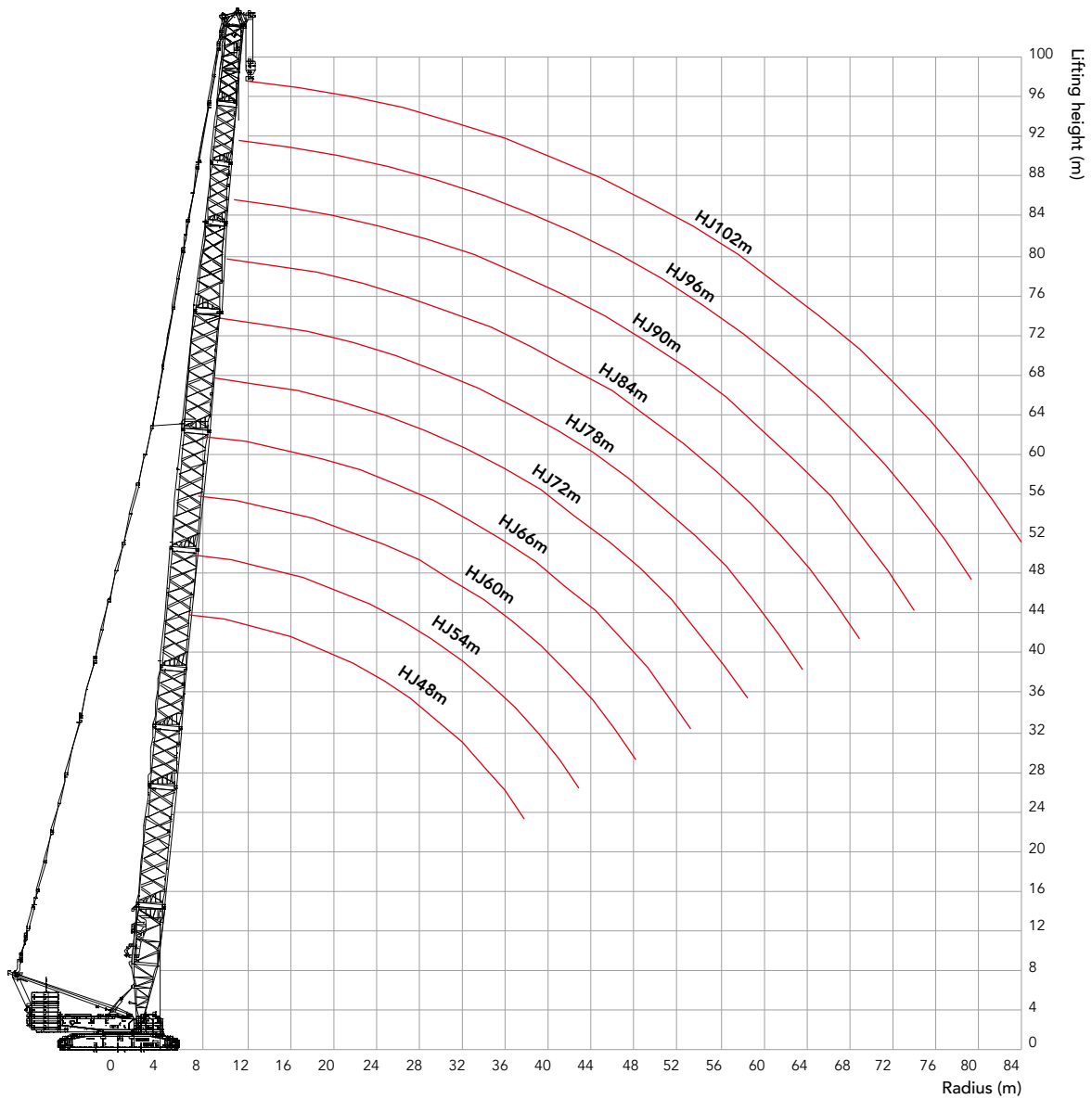

**Load Chart of HJ**

SCE6000A Crawler Crane—HJ Configuration											
Boom length 48~102m, Rear counterweigh 200t, Carbody counterweight 50t											
Boom length Radius(m)	48	54	60	66	72	78	84	90	96	102	Boom length Radius(m)
8	280										8
9	282	277	273								9
10	284	282	276	266	255						10
11	275	263	252	242	232	223	214				11
12	249	239	230	221	213	205	197	170	159		12
14	209	202	195	188	182	175	169	163	155	134	14
16	180	174	169	163	158	153	148	143	138	131	16
18	157	152	148	143	139	135	130	126	123	119	18
20	139	135	131	127	124	120	116	113	109	106	20
22	123	121	118	114	111	108	104	101	98.9	96.2	22
24	109	109	107	103	101	98.1	95.0	92.0	89.6	87.1	24
26	97.8	97.4	97.1	94.6	92.1	89.3	86.4	83.7	81.5	79.3	26
28	88.2	87.7	87.4	86.6	84.3	81.7	79.1	76.5	74.5	72.5	28
30	80.0	79.5	79.2	78.5	77.5	75.1	72.6	70.2	68.4	66.5	30
32	73.0	72.5	72.2	71.5	71.0	69.3	66.9	64.7	62.9	61.2	32
34	66.9	66.4	66.1	65.4	64.9	64.1	61.8	59.7	58.1	56.4	34
36	61.5	61.1	60.8	60.1	59.5	58.7	57.3	55.3	53.7	52.1	36
38	56.8	56.4	56.1	55.4	54.8	54.0	53.0	51.3	49.8	48.3	38
40	52.6	52.2	51.9	51.2	50.6	49.8	48.8	47.6	46.2	44.8	40
44	45.3	45.0	44.7	44.0	43.5	42.7	41.7	40.7	40.0	38.7	44
48		39.1	38.8	38.2	37.6	36.8	35.8	34.9	34.3	33.5	48
52			33.9	33.2	32.7	31.9	30.9	30.0	29.4	28.8	52
56				29.1	28.6	27.7	26.7	25.8	25.3	24.7	56
60					25.0	24.2	23.2	22.2	21.7	21.1	60
64						21.8	21.0	20.0	19.1	18.6	64
68							18.3	17.3	16.4	15.9	68
72								14.9	14.0	13.4	72
76									11.8	11.3	76
80									9.8	9.3	80
84										7.6	84
88										5.4	88



## Boom Combination in HJDB

Boom Combination in HJDB						
Boom length (m)	Boom insert				Jib insert	
	6m/ (H6)	12mA/ (H8A)	12mB/ (H8B)	12mC/ (H8C)	6m/ (LJ6A)	12m/ (LJ7A)
78	2	1	2	-	-	-
84	1	1	2	1	-	-
90	2	1	2	1	-	-
96*	2	1	2	1	1	-
102*	2	1	2	1	2	-
108*	2	1	2	1	1	1
114*	2	1	2	1	2	1
120*	2	1	2	1	1	2
126*	2	1	2	1	2	2

Note: For combinations of 96m and more, marked with "\*", the mid-point suspension cable must be used, otherwise, the boom system may break.  
The use of mid-point suspension cable must be strictly in accordance with the Operation Manual.

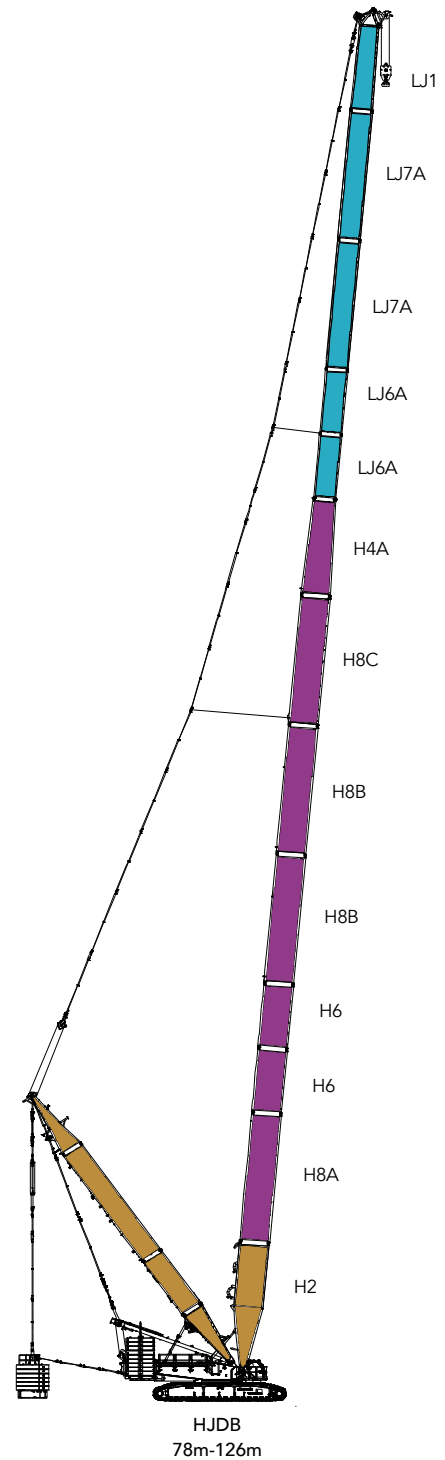

## Working Radius in HJDB

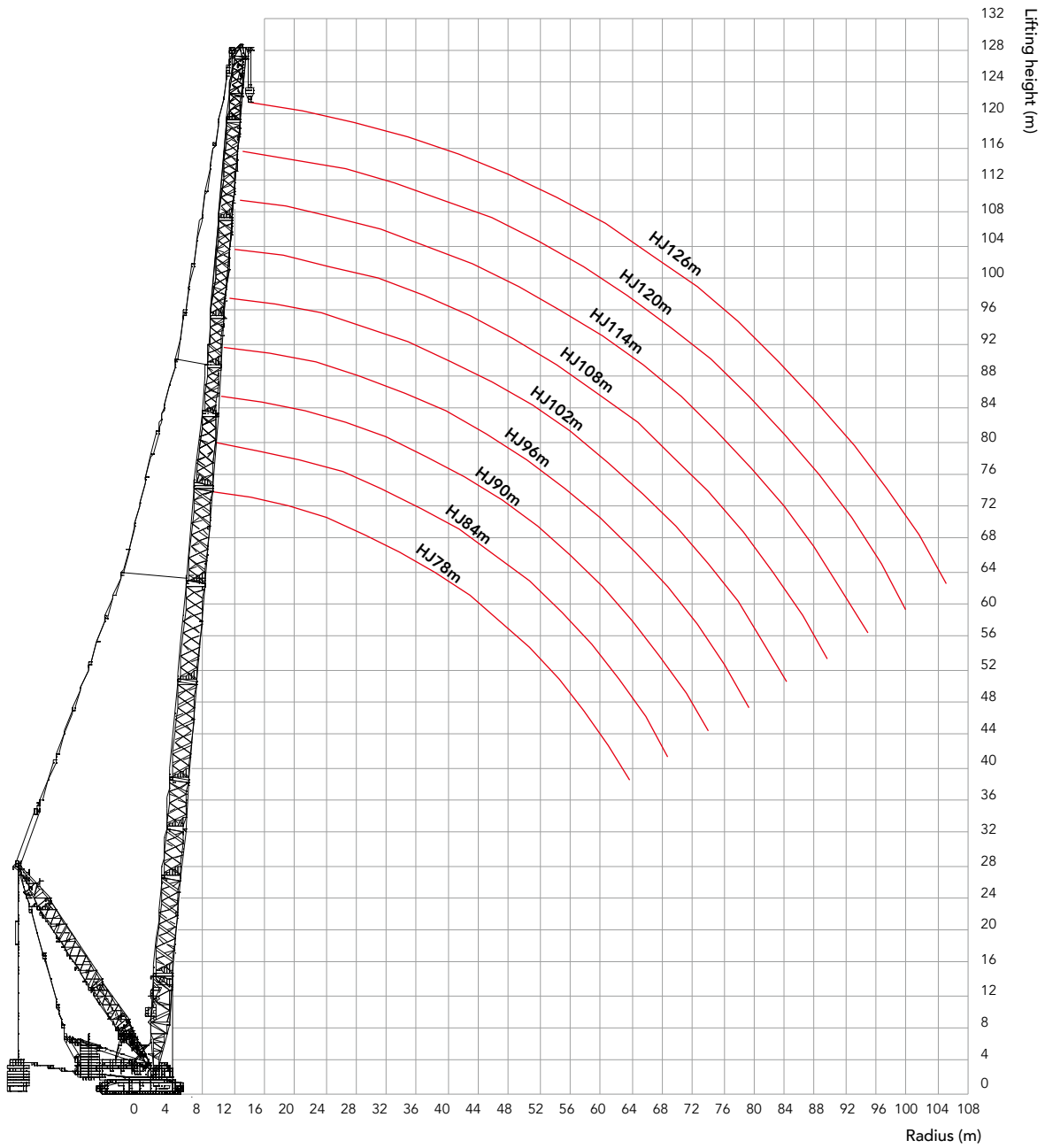

Unit: t

**Load Chart of HJDB**

SCE6000A Crawler Crane—HJDB Configuration										
Boom length 78~126m, Superlift radius 16m, Superlift counterweight 250t, Rear counterweight 160t, Carbody counterweight 50t										
Boom length (m) Radius(m)	78	84	90	96	102	108	114	120	126	Boom length (m) Radius(m)
11	257*	227*								11
12	258*	227*	194*	166*						12
14	260*	228*	194*	165*	143*	122*	107*	92.5*		14
16	262*	228*	194*	166*	143*	122*	107*	92.5*	79.5*	16
18	265*	228*	194*	166*	143*	123*	107*	91.7*	78.8*	18
20	268	228*	194*	166*	143*	123*	107*	90.9*	78.0*	20
22	269	227	194*	166*	143*	123*	106*	90.1*	77.2*	22
24	270	228	193	166*	143*	123*	105*	89.2*	76.4*	24
26	269	228	193	167*	142*	122*	105*	88.6*	75.6*	26
28	250	227	192	167	141*	121*	104*	87.7*	74.7*	28
30	230	225	190	166	140*	121*	103*	86.8*	73.9*	30
32	212	211	188	165	139	120*	102*	85.9*	73.1*	32
34	196	196	186	164	137	119*	101*	85.0*	72.2*	34
36	183	182	181	163	133	118	100*	84.1*	71.4*	36
38	171	170	169	162	130	117	99.8*	83.2*	70.5*	38
40	160	159	158	158	126	116	97.4*	82.3*	69.7*	40
44	142	141	140	140	120	114	91.4*	77.5*	66.6*	44
48	127	126	125	125	115	112	86.6	73.2*	62.4*	48
52	114	113	113	112	110	106	82.0	69.0*	58.8*	52
56	104	103	102	102	101	101	77.9	65.4*	55.2*	56
60	95.1	94.2	93.4	93.0	92.5	92.3	74.2	62.1	52.5*	60
64	87.2	86.3	85.5	85.1	84.6	84.4	71.4	59.3	49.9*	64
68	80.3	79.4	78.6	78.2	77.7	77.5	68.7	56.8	47.8*	68
72		73.3	72.5	72.1	71.6	71.4	66.5	54.8	46.0*	72
76			67.0	66.6	66.1	65.9	64.4	53.2	44.3	76
80			62.1	61.7	61.3	61.1	60.5	51.7	42.9	80
84				57.3	56.9	56.7	56.1	50.6	41.6	84
88					52.9	52.7	52.1	49.9	40.7	88
92						49.0	48.5	48.2	40.0	92
96							45.7	44.8	39.5	96
100								42.1	41.8	100
104									39.0	104
108										108

Note: For values above with “\*”, the superlift counterweight must not leave the ground.

### Boom Combination in HJFJ\_3

Boom Combination in HJFJ_3							
Boom length (m)	Standard boom insert				Power boom insert		
	3m/(H5)	6m/(H6)	12mA/(H8B)	12mA/(H8C)	12m lower transitional insert/(ZH4A)	12m insert/(ZH6)	12m upper transitional insert/(ZH4B)
78*	-	-	-	1	1	2	1
84*	-	1	-	1	1	2	1
90*	-	-	1	1	1	2	1
93*	1	-	1	1	1	2	1
96*	-	1	1	1	1	2	1
99*	1	1	1	1	1	2	1
102*	-	2	1	1	1	2	1

Note: For combinations with "\*", the mid-point suspension cable must be used, otherwise, the boom system may break.

The use of mid-point suspension cable must be strictly in accordance with the Operation Manual.

Attention: If the boom length is 78m and more, the crane must boom up from side by side erection outrigger or from the front by the special front erection outrigger, otherwise, the crane may tip over!

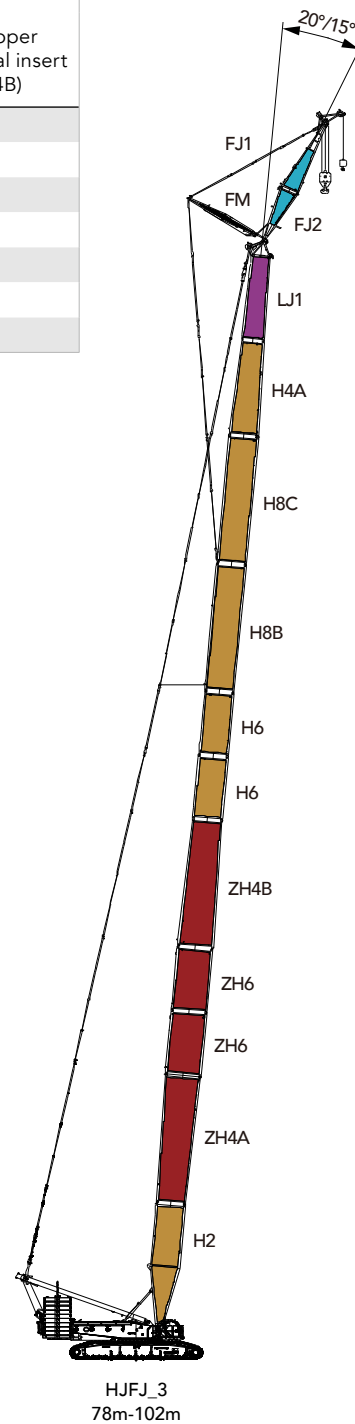

### Working Radius in HJFJ\_3

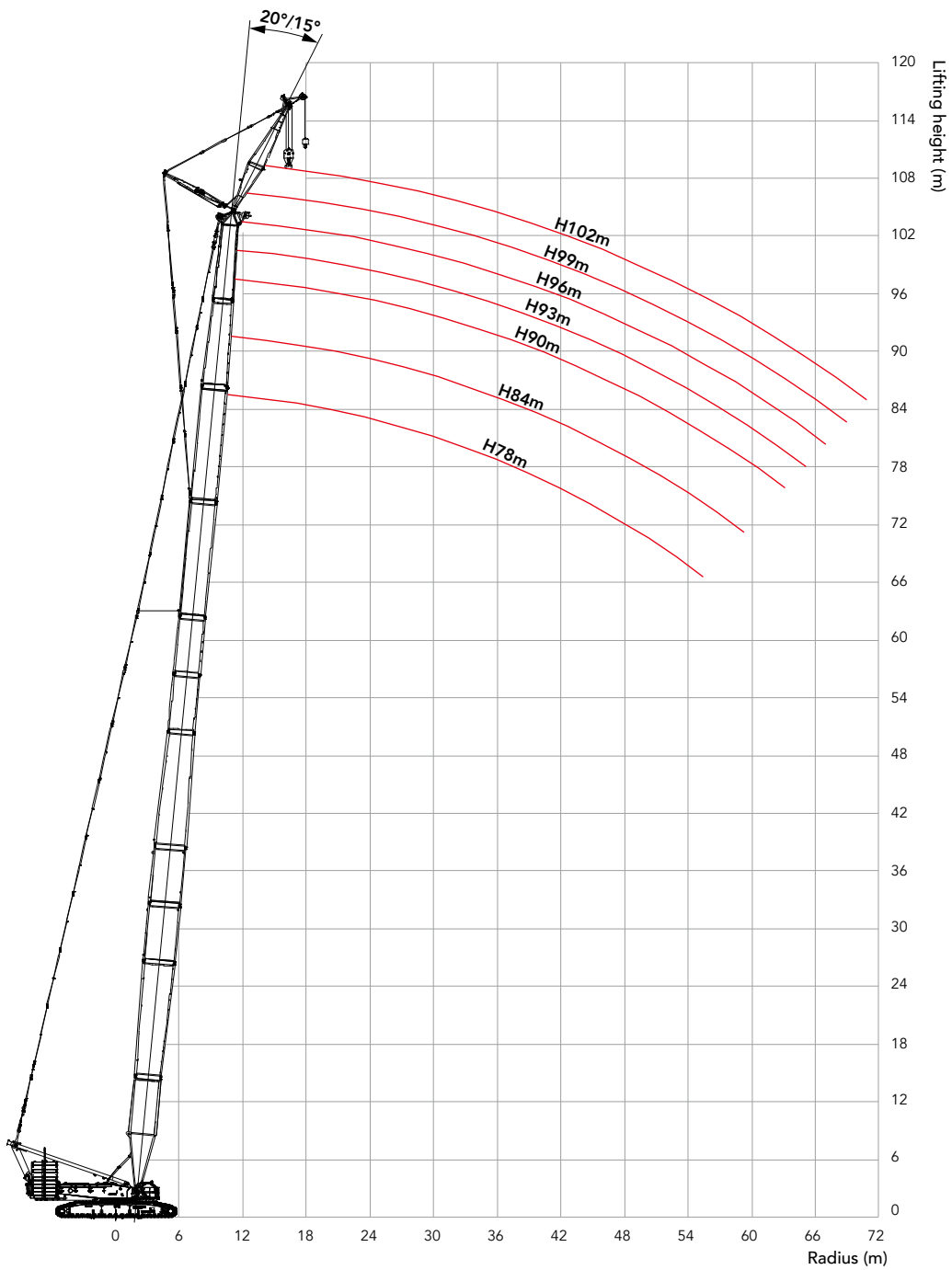

**Load Chart of HJFJ\_3**

SCE6000A Crawler Crane- HJFJ_3 Configuration 1/2								
Boom length 78m~102m, Jib length 12m, Offset angle 15°, Rear counterweight 160t, Additional counterweight 47t, Carbody counterweight 50t								
Boom length (m) Radius(m)	78	84	90	93	96	99	102	Boom length (m) Radius(m)
16	167	165	147	148	145	143	133	16
18	152	149	141	144	142	139	132	18
20	139	135	135	134	133	130	129	20
22	127	124	124	123	122	120	118	22
24	117	114	115	113	111	110	109	24
26	108	105	105	104	102	101	100	26
28	101	97.7	97.2	95.7	94.5	93.1	91.9	28
30	93.4	90.8	89.5	88.2	87.1	85.7	84.6	30
32	87.2	84.8	82.8	81.5	80.5	79.2	78.1	32
34	80.9	78.6	76.7	75.5	74.5	73.3	72.3	34
36	75.2	73.1	71.3	70.1	69.2	68.1	67.1	36
38	70.1	67.9	66.4	65.3	64.4	63.3	62.4	38
40	65.5	63.3	61.9	60.9	60.0	58.9	58.1	40
44	56.9	54.8	54.1	53.1	52.3	51.3	50.5	44
48	49.4	48.6	47.5	46.6	45.8	44.9	44.1	48
52	43.1	42.3	41.8	40.9	40.3	39.3	38.6	52
56	37.7	36.9	36.4	35.9	35.4	34.5	33.8	56
60	33.0	32.3	31.8	31.3	30.9	30.3	29.6	60
64	28.9	28.2	27.7	27.2	26.9	26.4	25.8	64
68	25.3	24.7	24.2	23.7	23.4	22.9	21.9	68
72	22.1	21.5	21.0	20.5	20.2	19.7	19.0	72
76	19.2	18.6	18.2	17.7	17.4	16.9	16.3	76
80	16.5	16.0	15.6	15.1	14.9	14.3	13.7	80
84		13.6	13.2	12.8	12.5	12.0	11.4	84
88			11.1	10.6	10.4	9.9	9.4	88
92			9.0	8.6	8.4	7.9	7.3	92
96					6.6	6.1	5.3	96
100						4.4	3.7	100

Unit: t

### Load Chart of HJFJ\_3

SCE6000A Crawler Crane- HJFJ_3 Configuration 2/2								
Boom length 78m~102m, Jib length 12m, Offset angle 20°, Rear counterweight 160t, Additional counterweight 47t, Carbody counterweight 50t								
Boom length (m) Radius(m)	78	84	90	93	96	99	102	Boom length (m) Radius(m)
16	155	155	137	139				16
18	149	149	133	135	133	131	130	18
20	137	135	129	131	130	128	126	20
22	127	125	124	122	120	119	118	22
24	116	114	114	112	112	110	109	24
26	108	105	105	104	103	101	100	26
28	99.9	97.5	97.9	96.4	95.2	93.7	92.6	28
30	93.5	90.7	90.2	88.9	87.7	86.4	85.3	30
32	87.7	84.1	83.4	82.1	81.1	79.8	78.8	32
34	81.4	78.6	77.3	76.1	75.1	73.9	72.9	34
36	75.7	72.4	71.8	70.7	69.8	68.6	67.7	36
38	70.6	67.5	66.9	65.8	64.9	63.8	62.9	38
40	65.9	63.0	62.4	61.3	60.5	59.4	58.6	40
44	57.3	55.3	54.5	53.5	52.8	51.8	51.0	44
48	49.7	47.9	47.9	46.9	46.2	45.2	44.5	48
52	43.3	42.6	42.1	41.2	40.6	39.7	38.8	52
56	37.9	37.2	36.6	36.1	35.7	34.8	33.8	56
60	33.2	32.5	32.0	31.5	31.2	30.5	29.6	60
64	29.1	28.4	27.9	27.4	27.1	26.6	25.7	64
68	25.4	24.8	24.3	23.8	23.6	23.0	22.2	68
72	22.2	21.6	21.1	20.7	20.4	19.9	19.2	72
76	19.2	18.7	18.3	17.8	17.5	17.0	16.3	76
80	16.5	16.0	15.7	15.2	15.0	14.5	13.7	80
84		13.6	13.3	12.8	12.6	12.1	11.4	84
88			11.1	10.7	10.4	10.0	9.3	88
92			9.0	8.6	8.4	8.0	7.5	92
96					6.6	6.1	5.4	96
100						4.4	3.7	100

## Boom Combination in HJFJDB\_6

Boom Combination in HJFJDB_6									
Boom length (m)	Standard boom insert				Power boom insert				
	3m/ (H5)	6m/ (H6)	12mA/ (H8A)	12mA/ (H8C)	12m lower transitional insert/ (ZH4A)	12m power boom insert A/ (ZH8A)	12m power boom insert B/ (ZH8B)	6m power boom insert/ (ZH6)	12m upper transitional insert/ (ZH4B)
93*	1	-	-	-	1	1	1	2	1
96*	-	1	-	-	1	1	1	2	1
99*	1	1	-	-	1	1	1	2	1
102*	-	-	-	-	1	1	2	2	1
105*	1	-	-	-	1	1	2	2	1
108*	-	1	-	-	1	1	2	2	1
111*	1	1	-	-	1	1	2	2	1
114*	-	-	-	1	1	1	2	2	1
117*	1	-	-	1	1	1	2	2	1
120*	-	1	-	1	1	1	2	2	1
123*	1	1	-	1	1	1	2	2	1
126*	-	-	1	1	1	1	2	2	1
129*	1	-	1	1	1	1	2	2	1
132*	-	1	1	1	1	1	2	2	1

Note: For combinations with "\*" , the mid-point suspension cable must be used, otherwise, the boom system may break.

The use of mid-point suspension cable must be strictly in accordance with the Operation Manual.

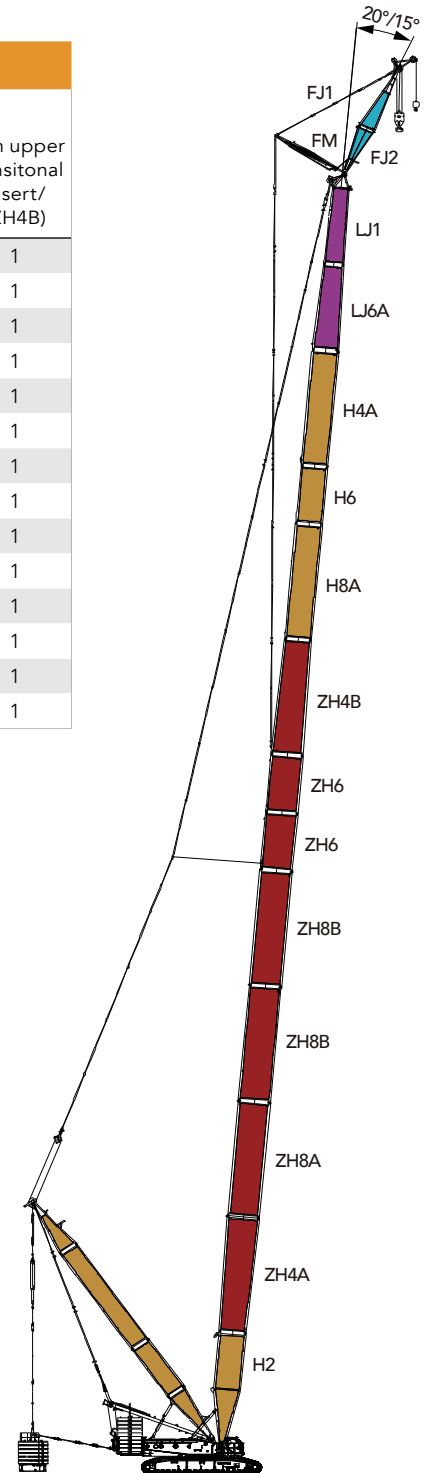

HJFJDB\_6  
93m-132m



## Working Radius in HJFJDB\_6

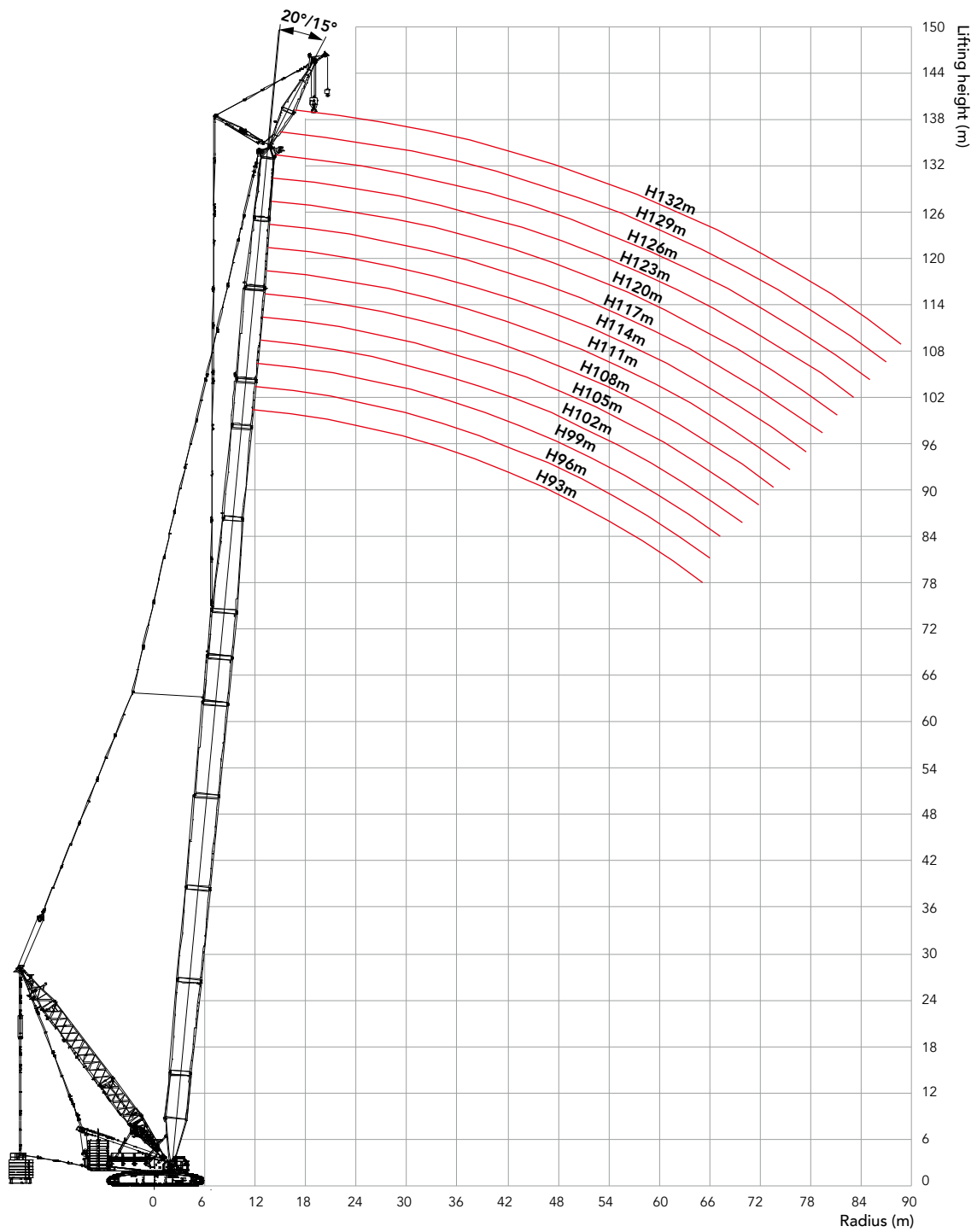

## Load Chart of HJFJDB\_6

### SCE6000A Crawler Crane- HJFJDB\_6 Configuration

Boom length 93m~144m, Jib length 12m, Offset angle 15°, Superlift radius 18m, Superlift counterweight 250t, Rear counterweight 160t, Carbody counterweight 50t

Boom (m) R (m)	93	96	99	102	105	108	111	114	117	120	123	126	129	132	135	138	141	144	Boom (m) R(m)
16	200*	200*	200*	198*															16
18	200*	200*	200*	196*	195*	190*	180*	170*	166*	160*	152*	140*							18
20	200*	200*	200*	196*	195*	190*	180*	170*	166*	160*	152*	140*	133*	130*	124*				20
22	200*	200*	195*	196*	195*	185*	180*	170*	166*	160*	152*	140*	133*	130*	124*	118*	110*	100*	22
24	192*	192*	190*	192*	190*	182*	178*	166*	162*	158*	149*	138*	132*	130*	124*	118*	110*	100*	24
26	188*	187*	186*	185*	180*	178*	173*	162*	160*	152*	146*	136*	130*	128*	124*	118*	110*	100*	26
28	180*	180*	178*	176*	172*	170*	166*	159*	156*	150*	142*	132*	129*	126*	123*	118*	110*	100*	28
30	176*	175*	172*	170*	170*	165*	160*	158*	153*	150*	140*	130*	127*	125*	122*	112*	110*	102*	30
32	173*	172*	168*	166*	163*	160*	158*	156	150	145*	138*	130*	126*	124*	120*	110*	108*	102*	32
34	168	166	163*	162	158	154	152*	150	148	142*	136*	126*	125	120	117	106	104	101	34
36	164	162	160*	155	152	150	148	147	146	132	132	125	123	120	117	104	101	101	36
38	161	158	156*	152	150	148	147	145	143	128	128	123	120	118	115	102	100	100	38
40	156	152	150*	146	145	142	138	135	130	124	123	120	117	116	112	100	98	95	40
44	150	147	144	141	140	136	132	129	125	122	121	118	114	112	110	100	97	94	44
48	142	140	136	132	130	128	126	122	120	114	112	110	110	109	105	102	96	92	48
52	133	130	128	125	120	120	118	114	110	106	102	100	100	98	94	90	84.6	84	52
56	123	120	117	114	110	108	106	102	100	98.2	89.7	89.2	86.1	85.2	83.2	82.8	78.8	77.8	56
60	110.8	100.5	95.2	93.7	92.2	90.2	88.2	91.2	90.6	89.5	83.8	81.5	77.9	75.4	72.4	71.4	68.5	67.4	60
64	97.9	89.1	85.6	84.5	83.7	83.5	82.4	82.7	82.1	81.9	79.5	77.4	74.0	70.6	68.6	66.5	64.2	62.5	64
68	85.6	80.2	76.9	76.9	76.3	76.1	75.5	75.3	74.7	74.4	73.9	73.3	70.1	66.9	64.8	63.1	62.1	60.1	68
72	78.9	74.7	71.2	70.3	69.7	69.5	69.0	68.7	68.1	67.9	67.3	67.0	66.4	63.4	62.4	61.4	57.1	55.8	72
76	68.0	66.8	65.3	64.4	63.6	63.7	63.1	62.9	62.3	62.0	61.4	61.1	60.5	60.2	59.1	57.8	52.5	50.4	76
80	62.7	61.5	60.0	59.2	58.6	58.4	57.8	57.6	57.0	56.8	56.2	55.9	55.3	55.0	53.6	52.8	48.6	47.7	80
84	56.9	56.7	55.3	54.4	53.8	53.7	53.1	52.9	52.3	52.0	51.5	51.2	50.6	50.3	48.3	47.3	42.8	42	84
88	52.5	51.3	50.9	50.0	49.5	49.3	48.8	48.6	48.0	47.7	47.2	46.9	46.3	46.0	43.0	42.0	38.9	37.5	88
92	48.4	47.3	46.9	46.1	45.6	45.4	44.8	44.6	44.1	43.8	43.2	43.0	42.3	42.1	40.1	38.6	35.8	34.1	92
96		44.6	43.2	42.4	41.9	41.7	41.2	41.0	40.5	40.2	39.6	39.4	38.7	38.5	36.6	35.2	32.6	31.2	96
100			39.8	39.0	38.5	38.4	37.9	37.7	37.1	36.9	36.3	36.0	35.4	35.2	34.1	32.6	30.1	28.8	100
104					35.4	35.2	34.7	34.6	34.0	33.8	33.2	33.0	32.4	32.1	30.1	28.3	25.8	24.2	104
108							31.8	31.7	31.2	30.9	30.4	30.1	29.5	29.3	27.3	26.5	23.6	22.3	108
112								29.0	28.5	28.3	27.7	27.5	26.9	26.6	23.6	21.6	20.1	19.8	112
116										25.7	25.2	25.0	24.4	24.2	22.3	20.4	18	27.2	116
120											22.9	22.6	22.1	21.9	20.2	19.2	16.2	15.1	120
124													19.9	19.7	17.9	15.9	13.2	12.3	124
128														17.6	16.5	13.5	11.8	10.1	128
132																10.6	9.5	8.1	132
136																	7.2	6.5	136

## Boom Combination in LJ(DB)

### Boom Combination in LJ(DB)

Jib length (m)	Jib insert				Boom length (m)
	6 mA	6mB	12mA	12mB	
24	1	-	-	-	36~60(LJ) 36~84(LJDB) 60m+72/84+84 (Longest boom+longest jib) 85° 75° 65°
30	2	-	-	-	
36	1	-	1	-	
42	2	-	1	-	
48	1	-	2	-	
54	2	-	2	-	
60	2	1	2	-	
66*	2	-	2	1	
72*	2	1	2	1	
78*	2	-	2	2	
84*	2	1	2	2	

Note: In LJ configuration, the boom length is 24m~72m, and in LJDB, 24m~84m.  
For combinations of 66m~84m, marked with "\*", the mid-point suspension cable must be used for jib, otherwise, the boom system may break.  
Attention: In LJ configuration, the crane must boom up strictly in accordance with LJ Erection and Lowering Table in Operation Manual, otherwise, the crane may tip over!

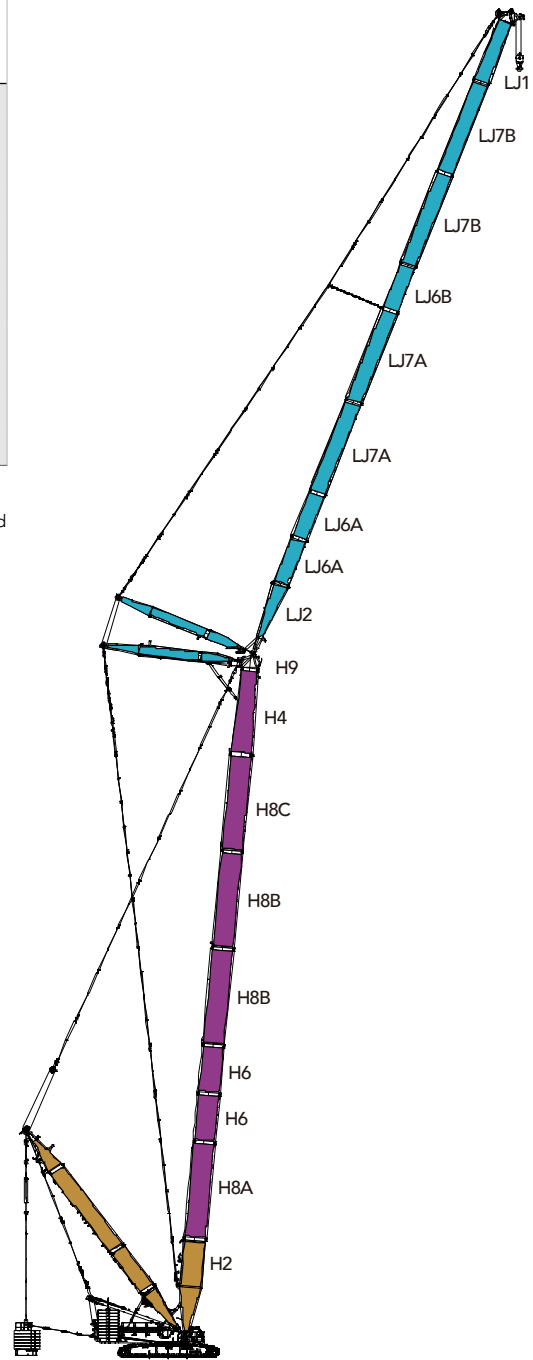

LJ(DB)  
LJ: (36m-60m)+(24m-72m)  
LJDB: (36m-84m)+(24m-84m)

**Working Radius in LJ(DB)**

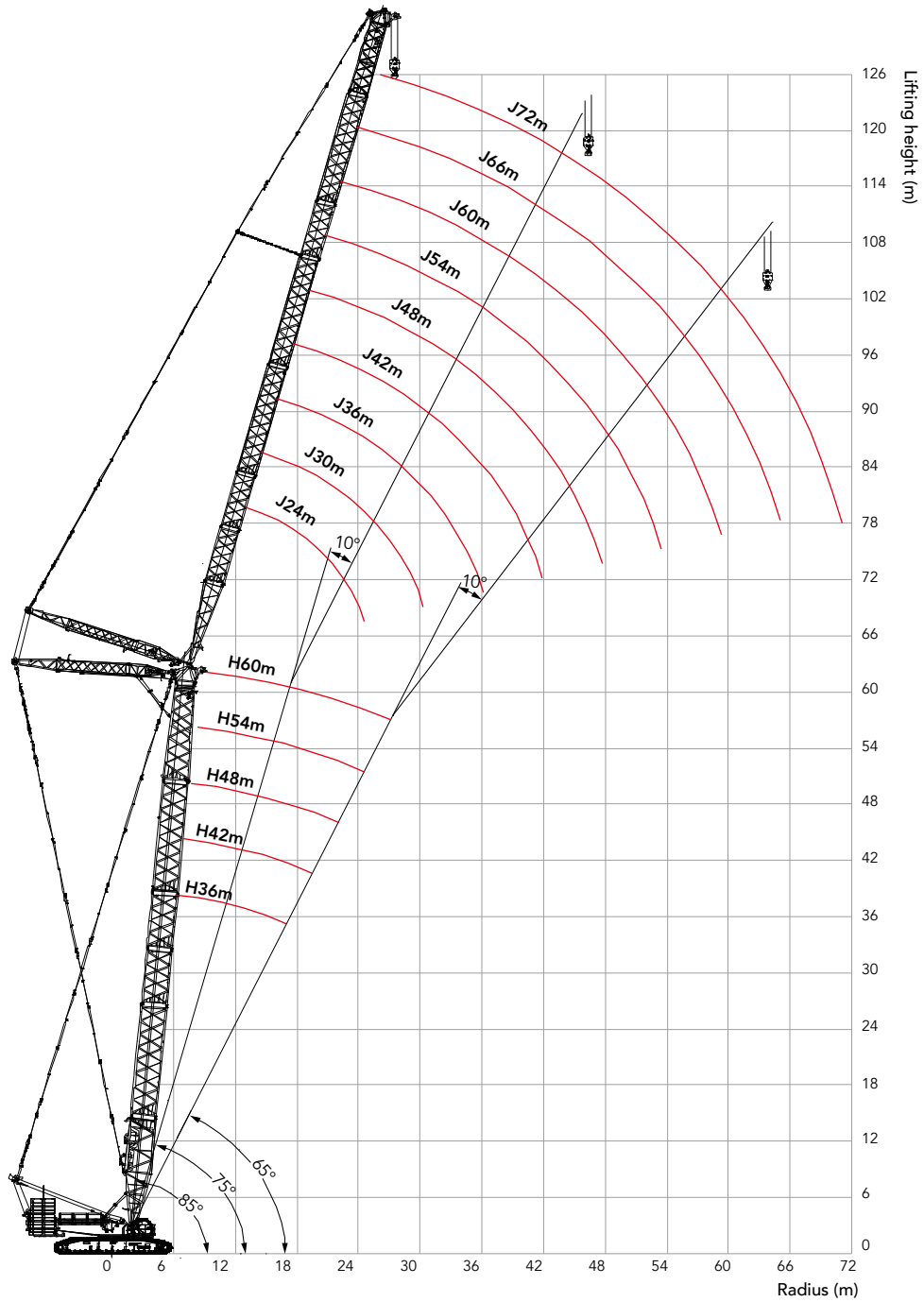

**Load Chart of LJ**

SCE6000A Crawler Crane—LJ Configuration 1/5										
Boom length 36m, Boom angle 85° , Jib length 24~72m, Rear counterweight 200t, Carbody counterweight 50t										
Boom length Radius(m)	24	30	36	42	48	54	60	66	72	Boom length Radius(m)
14	206									14
16	179	174								16
18	159	154	150	145						18
20	143	138	134	130	127					20
22	129	125	122	118	115	112				22
24	118	115	111	108	105	102	99.8	95.6		24
26	108	105	103	99.9	97.3	94.5	91.9	89.7	81.5	26
28	98.8	97.8	95.3	92.4	90.0	87.5	85.1	83.0	80.1	28
30		90.5	88.6	85.9	83.6	81.2	79.0	77.1	74.9	30
32		83.0	82.7	80.1	78.0	75.8	73.7	71.9	69.8	32
34		76.4	76.6	75.0	73.0	70.9	68.9	67.2	65.3	34
36			71.0	70.4	68.5	66.5	64.6	63.0	61.2	36
38			66.0	65.5	64.5	62.6	60.7	59.3	57.5	38
40			61.4	61.0	60.7	59.0	57.2	55.8	54.1	40
44				53.4	53.2	52.6	51.1	49.8	48.2	44
48					47.0	46.5	45.9	44.8	43.3	48
52					41.7	41.3	40.8	40.4	39.0	52
56						36.9	36.4	36.1	35.3	56
60							32.6	32.3	31.7	60
64								29.1	28.5	64
68								26.1	25.6	68
72									23.0	72

Unit: t

## Load Chart of LJ

SCE6000A Crawler Crane—LJ Configuration 2/5										
Boom length 42m, Boom angle 85° , Jib length 24~72m, Rear counterweight 200t, Carbody counterweight 50t										
Boom length Radius(m)	24	30	36	42	48	54	60	66	72	Boom length Radius(m)
14	197									14
16	173	167								16
18	154	149	144							18
20	138	134	130	126	122					20
22	125	122	118	115	111	108				22
24	114	111	108	105	102	99.5	96.7			24
26	105	102	100	97.0	94.4	91.7	89.2	87.0	77.0	26
28	98.0	95.1	92.6	89.8	87.4	84.9	82.5	80.5	75.5	28
30		88.5	86.2	83.5	81.3	78.9	76.7	74.8	72.7	30
32		82.6	80.5	77.9	75.9	73.7	71.6	69.8	67.8	32
34		76.2	75.4	73.0	71.1	68.9	67.0	65.3	63.4	34
36			70.7	68.6	66.7	64.7	62.8	61.3	59.4	36
38			65.7	64.6	62.8	60.9	59.1	57.6	55.8	38
40			61.2	60.8	59.3	57.4	55.7	54.3	52.6	40
44				53.2	53.0	51.4	49.8	48.5	46.9	44
48					46.8	46.2	44.7	43.5	42.0	48
52					41.5	41.1	40.5	39.3	37.9	52
56						36.7	36.2	35.7	34.3	56
60							32.4	32.1	31.1	60
64							29.1	28.9	28.3	64
68								26.0	25.4	68
72									22.9	72

**Load Chart of LJ**

SCE6000A Crawler Crane—LJ Configuration 3/5										
Boom length 48m, Boom angle 85° , Jib length 24~72m, Rear counterweight 200t, Carbody counterweight 50t										
Boom length Radius(m)	24	30	36	42	48	54	60	66	72	Boom length Radius(m)
16	167	161								16
18	148	144	139							18
20	134	130	126	122						20
22	121	118	115	111	108	105				22
24	111	108	105	102	99.4	96.5	93.3			24
26	102	99.8	97.2	94.2	91.7	89.0	86.5	80.2		26
28	95.2	92.5	90.1	87.3	85.0	82.5	80.1	77.9	69.3	28
30	88.8	86.1	83.8	81.2	79.1	76.7	74.5	72.7	67.7	30
32		80.4	78.3	75.9	73.8	71.6	69.5	67.8	65.7	32
34		75.4	73.4	71.1	69.2	67.1	65.1	63.5	61.5	34
36			69.0	66.8	65.0	63.0	61.1	59.5	57.7	36
38			65.1	62.9	61.2	59.3	57.5	56.0	54.2	38
40			61.1	59.4	57.8	55.9	54.2	52.8	51.1	40
44				53.1	51.8	50.0	48.4	47.1	45.5	44
48					46.6	45.1	43.5	42.3	40.8	48
52					41.4	40.8	39.4	38.2	36.8	52
56						36.5	35.7	34.7	33.3	56
60							32.3	31.5	30.2	60
64							28.9	28.7	27.5	64
68								25.8	25.0	68
72									22.7	72
76									20.4	76

Unit: t

**Load Chart of LJ**

SCE6000A Crawler Crane—LJ Configuration 4/5										
Boom length 54m, Boom angle 85° , Jib length 24~72m, Rear counterweight 200t, Carbody counterweight 50t										
Boom length Radius(m)	24	30	36	42	48	54	60	66	72	Boom length Radius(m)
16	160									16
18	143	139	135							18
20	129	125	122	118						20
22	117	114	111	107	104					22
24	108	105	102	99.0	96.3	93.4	84.8			24
26	99.7	96.9	94.3	91.4	88.9	86.2	82.2	72.9		26
28	92.5	89.8	87.4	84.7	82.4	80.0	77.6	71.1	63.4	28
30	86.2	83.6	81.4	78.9	76.7	74.4	72.2	68.9	61.9	30
32		78.2	76.1	73.7	71.7	69.5	67.4	65.7	60.1	32
34		73.3	71.4	69.1	67.2	65.1	63.2	61.5	58.2	34
36		69.1	67.2	64.9	63.1	61.1	59.3	57.8	55.9	36
38			63.4	61.2	59.5	57.6	55.8	54.3	52.6	38
40			59.9	57.8	56.2	54.3	52.6	51.2	49.5	40
44				51.9	50.4	48.6	47.0	45.7	44.1	44
48					45.5	43.8	42.3	41.1	39.6	48
52					41.2	39.7	38.2	37.1	35.6	52
56						36.1	34.7	33.6	32.2	56
60							31.6	30.6	29.2	60
64							28.7	27.9	26.6	64
68								25.5	24.2	68
72									22.1	72
76									20.1	76



**Load Chart of LJ**

SCE6000A Crawler Crane—LJ Configuration 5/5										
Boom length 60m, Boom angle 85° , Jib length 24~72m, Rear counterweight 200t, Carbody counterweight 50t										
Boom length Radius(m)	24	30	36	42	48	54	60	66	72	Boom length Radius(m)
16	154									16
18	138	134								18
20	125	121	117	114						20
22	114	110	107	104	100					22
24	104	101	98.9	95.8	93.1	86.3				24
26	96.6	93.8	91.3	88.5	86.0	82.7	74.3	66.6		26
28	89.7	87.1	84.8	82.1	79.8	77.4	71.8	64.5	57.9	28
30	83.6	81.1	79.0	76.5	74.4	72.1	68.8	62.4	56.2	30
32		75.9	73.9	71.5	69.5	67.3	65.3	60.3	54.4	32
34		71.2	69.3	67.0	65.2	63.1	61.2	57.7	52.6	34
36		67.0	65.2	63.0	61.3	59.3	57.4	55.2	50.8	36
38			61.5	59.4	57.7	55.8	54.0	52.6	48.8	38
40			58.2	56.1	54.5	52.7	51.0	49.6	47.0	40
44				50.4	48.9	47.2	45.6	44.3	42.7	44
48				45.3	44.1	42.5	41.0	39.8	38.3	48
52					39.3	38.5	37.0	35.9	34.5	52
56						34.0	33.5	32.5	31.1	56
60						29.7	29.5	29.3	28.2	60
64							26.1	26.1	25.5	64
68								23.1	22.8	68
72									20.5	72
76									18.3	76

## Working Radius in LJDB

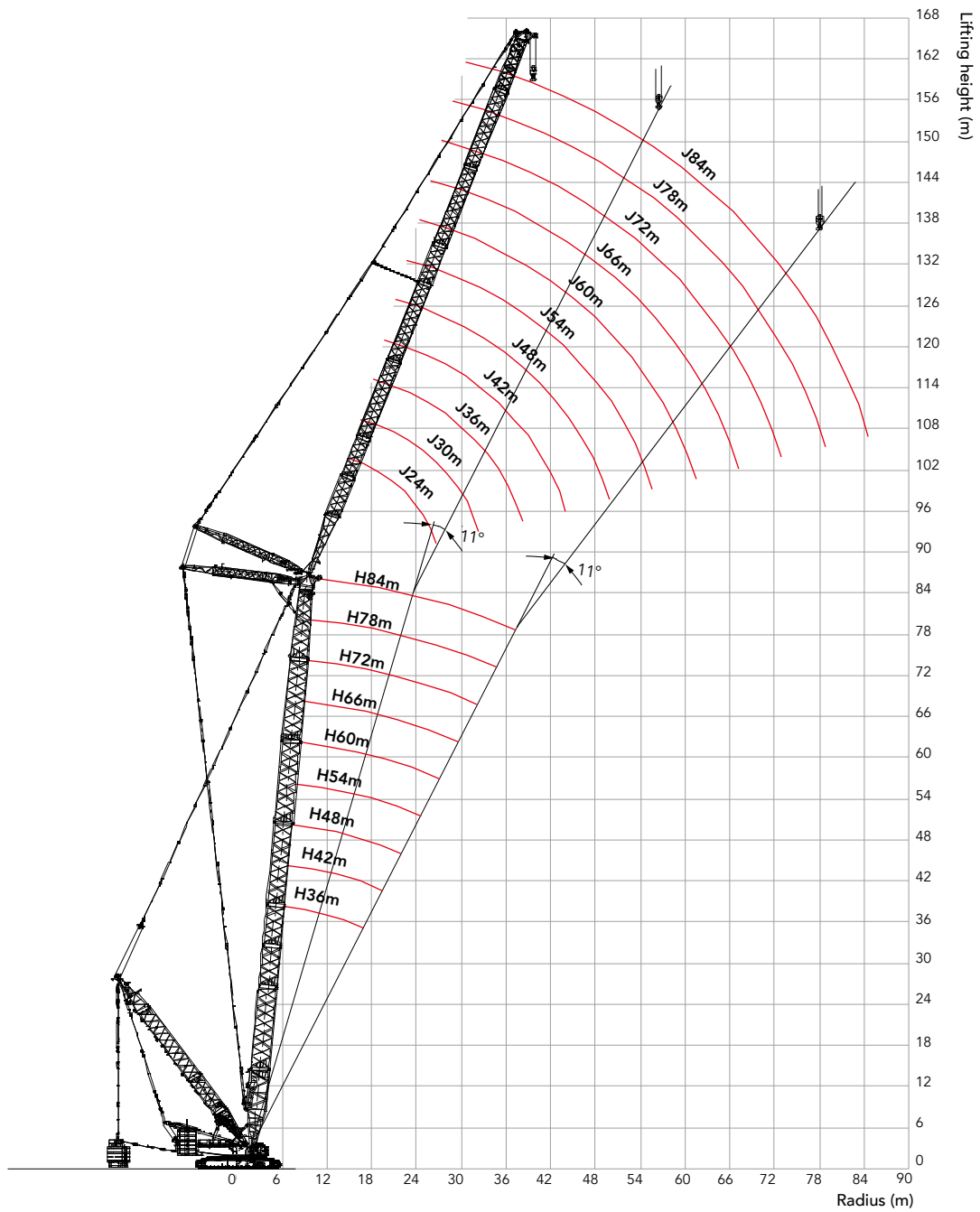

## Load Chart of LJDB

SCE6000A Crawler Crane—LJDB Configuration 1/9												
Boom length 36m, Boom angle 85° , Jib length 24~84m, Superlift radius 16m, Superlift counterweight 250t, Rear counterweight 160t, Carbody counterweight 50t												
Boom length Radius(m)	24	30	36	42	48	54	60	66	72	78	84	Boom length Radius(m)
14	274*											14
16	264*	252*										16
18	256*	241*	223*	189*								18
20	241*	226*	212*	182*	155*							20
22	225*	214*	200*	175*	151*	129*						22
24	210*	201*	190*	168*	146*	127*	109*	94.3*				24
26	196*	191*	179*	160*	141*	123*	106*	92.8*	81.3*			26
28	185*	179*	167*	151*	135*	119*	104*	91.2*	79.9*	68.0*		28
30		164*	155*	143*	129*	115*	101*	89.1*	78.6*	67.5*	57.7*	30
32		150*	144*	134*	123*	110*	98.6*	87.0*	76.8*	66.6*	57.2*	32
34		137*	133*	126*	117*	106*	95.4*	84.9*	75.4*	65.4*	56.7*	34
36			123*	118*	110*	101*	91.6*	82.2*	73.6*	64.1*	56.2*	36
38			114*	109*	104*	96.9*	88.5*	79.6*	71.8*	62.8*	55.5*	38
40			104*	103*	98.6*	92.3*	84.7*	77.5*	70.0*	61.2*	54.4*	40
44				89.1*	86.9*	83.2*	77.9*	71.7*	65.6*	58.4*	52.2*	44
48					76.4*	74.9*	71.2*	66.5*	61.7*	55.2*	49.8*	48
52					66.8*	66.4*	64.5*	61.2*	57.2*	51.1*	47.4*	52
56						59.2*	57.9*	56.2*	53.0*	46.3*	44.6*	56
60							52.4*	51.3*	49.0*	41.6*	42.2*	60
64								46.3*	45.0*	37.6*	39.5*	64
68								42.1*	41.5*	33.7*	37.0*	68
72									37.9*	30.8*	34.5*	72
76										27.2*	32.2*	76
80										24.9*	29.5*	80
84											26.6*	84

Note: For values above with “\*”, the superlift counterweight must not leave the ground.

Unit: t

### Load Chart of LJDB

SCE6000A Crawler Crane—LJDB Configuration 2/9												
Boom length 42m, Boom angle 85° , Jib length 24~84m, Superlift radius 16m, Superlift counterweight 250t, Rear counterweight 160t, Carbody counterweight 50t												
Boom length Radius(m)	24	30	36	42	48	54	60	66	72	78	84	Boom length Radius(m)
14	272*											14
16	263*	247*										16
18	256*	240*	205*									18
20	245*	227*	196*	169*	145*							20
22	227*	211*	187*	162*	141*	121*						22
24	213*	195*	176*	155*	136*	119*	103*					24
26	192*	181*	165*	148*	131*	115*	100*	88.3*	77.0*			26
28	174*	166*	154*	140*	126*	111*	98.1*	86.4*	75.9*	64.9*		28
30		151*	143*	132*	120*	107*	95.2*	84.5*	74.3*	64.4*	54.9*	30
32		139*	133*	124*	114*	103*	92.3*	82.1*	73.1*	63.4*	54.5*	32
34		127*	124*	117*	108*	99.2*	89.4*	79.7*	71.4*	62.2*	54.1*	34
36			114*	109*	103*	95.0*	85.9*	77.2*	69.5*	61.1*	53.7*	36
38			105*	101*	97.0*	90.1*	83.0*	74.8*	67.9*	59.6*	53.0*	38
40			97.7*	94.9*	91.0*	85.9*	79.5*	72.4*	65.8*	58.1*	52.0*	40
44				82.7*	80.5*	76.9*	72.6*	67.0*	61.7*	55.1*	49.4*	44
48					70.7*	69.3*	65.8*	61.9*	57.7*	51.9*	47.2*	48
52					61.9*	61.6*	59.7*	56.7*	53.3*	48.7*	44.4*	52
56						54.6*	53.6*	51.7*	49.4*	45.4*	41.9*	56
60							48.2*	47.1*	45.2*	42.5*	39.3*	60
64							43.1*	42.6*	41.5*	38.0*	36.8*	64
68								38.3*	37.9*	34.3*	34.4*	68
72									34.6*	30.9*	31.8*	72
76										28.0*	29.4*	76
80										25.2*	27.3*	80
84											25.0*	84

Note: For values above with “\*”, the superlift counterweight must not leave the ground.

**Load Chart of LJDB**

SCE6000A Crawler Crane—LJDB Configuration 3/9												
Boom length 48m, Boom angle 85° , Jib length 24~84m, Superlift radius 16m, Superlift counterweight 250t, Rear counterweight 160t, Carbody counterweight 50t												
Boom length Radius(m)	24	30	36	42	48	54	60	66	72	78	84	Boom length Radius(m)
16	258*	221*										16
18	241*	211*	181*									18
20	223*	199*	175*	151*								20
22	205*	185*	165*	146*	127*	110*						22
24	187*	172*	156*	139*	123*	107*	94.5*					24
26	171*	160*	146*	132*	118*	104*	92.0*	81.1*				26
28	155*	146*	136*	125*	113*	101*	89.5*	79.0*	69.9*			28
30	141*	135*	128*	117*	108*	97.4*	86.9*	77.4*	68.9*	59.8*	51.1*	30
32		123*	118*	111*	103*	93.6*	84.3*	75.2*	67.0*	58.9*	50.8*	32
34		113*	110*	104*	97.6*	89.1*	81.1*	73.0*	65.5*	57.6*	50.5*	34
36			101*	97.4*	92.1*	85.3*	77.9*	70.8*	63.7*	56.3*	50.0*	36
38			94.4*	90.7*	86.7*	80.9*	74.8*	68.1*	61.8*	54.9*	49.1*	38
40			87.0*	84.8*	81.3*	77.0*	71.6*	65.9*	59.9*	53.6*	47.9*	40
44				73.1*	71.9*	68.9*	64.8*	60.8*	56.2*	50.7*	45.6*	44
48					63.1*	61.4*	58.6*	55.5*	52.1*	47.4*	43.1*	48
52					55.1*	54.6*	53.1*	50.8*	47.8*	44.3*	40.6*	52
56						48.3*	47.7*	46.1*	44.2*	40.9*	38.2*	56
60							42.5*	41.5*	40.3*	37.9*	35.6*	60
64							38.0*	37.4*	36.5*	34.9*	33.0*	64
68								33.7*	33.2*	32.0*	30.6*	68
72									30.2*	29.3*	28.2*	72
76									27.3*	26.9*	25.9*	76
80										24.3*	23.7*	80
84											21.8*	84
88											20.9*	88

Note: For values above with “\*”, the superlift counterweight must not leave the ground.

Unit: t

## Load Chart of LJDB

SCE6000A Crawler Crane—LJDB Configuration 4/9												
Boom length 54m, Boom angle 85° , Jib length 24~84m, Superlift radius 16m, Superlift counterweight 250t, Rear counterweight 160t, Carbody counterweight 50t												
Boom length Radius(m)	24	30	36	42	48	54	60	66	72	78	84	Boom length Radius(m)
16	226*											16
18	213*	186*	162*									18
20	196*	175*	155*	135*								20
22	181*	164*	147*	130*	115*							22
24	166*	153*	139*	125*	111*	98.2*	86.2*					24
26	152*	142*	131*	118*	106*	95.5*	84.0*	74.5*				26
28	139*	131*	122*	112*	102*	92.1*	81.7*	72.6*	64.7*			28
30	127*	120*	114*	106*	97.1*	88.1*	79.3*	71.1*	63.4*	55.3*		30
32		111*	106*	99.4*	92.7*	84.6*	76.4*	68.7*	61.7*	54.5*	47.1*	32
34		102*	98.6*	93.3*	87.7*	80.5*	73.5*	66.7*	60.0*	53.3*	46.9*	34
36		94.2*	91.4*	87.2*	82.7*	76.9*	70.6*	64.6*	58.3*	51.8*	46.4*	36
38			84.4*	81.3*	77.8*	72.9*	67.8*	62.2*	56.6*	50.6*	45.4*	38
40			78.3*	76.1*	72.9*	69.3*	64.4*	59.7*	54.9*	49.1*	44.3*	40
44				66.2*	64.5*	61.9*	58.7*	54.8*	51.1*	46.3*	42.0*	44
48					56.5*	55.1*	53.0*	50.0*	47.0*	43.0*	39.5*	48
52					49.8*	49.0*	47.4*	45.6*	43.2*	40.1*	36.9*	52
56						43.2*	42.4*	41.3*	39.6*	36.9*	34.5*	56
60							38.0*	37.1*	36.0*	33.8*	31.8*	60
64							33.7*	33.4*	32.5*	31.1*	29.5*	64
68								30.1*	29.4*	28.5*	27.2*	68
72									26.8*	26.0*	25.0*	72
76									24.1*	23.7*	22.9*	76
80										21.5*	20.8*	80
84											19.0*	84
88											17.3*	88

Note: For values above with “\*”, the superlift counterweight must not leave the ground.

## Load Chart of LJDB

SCE6000A Crawler Crane—LJDB Configuration 5/9												
Boom length 60m, Boom angle 85° , Jib length 24~84m, Superlift radius 16m, Superlift counterweight 250t, Rear counterweight 160t, Carbody counterweight 50t												
Boom length Radius(m)	24	30	36	42	48	54	60	66	72	78	84	Boom length Radius(m)
16	197*											16
18	186*	164*										18
20	174*	155*	138*	121*								20
22	160*	146*	131*	117*	104*							22
24	148*	136*	124*	111*	100*	89.2*						24
26	136*	126*	116*	106*	96.5*	86.1*	76.8*	68.2*				26
28	124*	117*	109*	101*	92.0*	82.9*	74.7*	66.5*	59.4*			28
30	114*	108*	102*	94.7*	87.4*	79.7*	72.0*	64.6*	57.9*	50.9*		30
32		100*	94.8*	89.1*	83.3*	76.4*	69.3*	62.8*	56.6*	50.2*	43.3*	32
34		91.6*	88.2*	83.5*	78.7*	72.7*	66.6*	60.6*	55.1*	49.1*	43.1*	34
36		85.0*	81.8*	78.0*	74.1*	69.4*	63.9*	58.7*	53.2*	47.7*	42.7*	36
38			75.7*	73.3*	69.6*	65.6*	61.2*	56.4*	51.6*	46.4*	41.8*	38
40			70.5*	68.1*	65.7*	62.3*	58.1*	54.1*	49.7*	45.0*	40.6*	40
44				59.4*	57.6*	55.4*	52.7*	49.5*	46.2*	42.2*	38.5*	44
48				51.8*	50.7*	49.3*	47.4*	45.0*	42.4*	38.9*	35.9*	48
52					44.3*	43.8*	42.3*	40.6*	38.6*	36.2*	33.3*	52
56						38.6*	37.8*	36.6*	35.2*	33.0*	31.0*	56
60						34.0*	33.8*	33.1*	31.9*	30.4*	28.7*	60
64							30.0*	29.5*	29.0*	27.6*	26.3*	64
68								26.6*	26.2*	25.3*	24.1*	68
72									23.4*	22.9*	22.1*	72
76									21.1*	20.8*	20.1*	76
80										18.8*	18.2*	80
84											16.5*	84
88											15.0*	88

Note: For values above with “\*”, the superlift counterweight must not leave the ground.

Unit: t

### Load Chart of LJDB

SCE6000A Crawler Crane—LJDB Configuration 6/9												
Boom length 66m, Boom angle 85° , Jib length 24~84m, Superlift radius 16m, Superlift counterweight 250t, Rear counterweight 160t, Carbody counterweight 50t												
Boom length Radius(m)	24	30	36	42	48	54	60	66	72	78	84	Boom length Radius(m)
16	174*											16
18	165*	146*										18
20	154*	138*	123*									20
22	143*	130*	118*	105*	94.0*							22
24	132*	121*	111*	100*	90.5*	80.8*						24
26	122*	113*	105*	95.7*	86.9*	78.0*	70.0*					26
28	112*	105*	98.5*	91.1*	83.2*	75.5*	67.6*	60.8*				28
30	103*	97.6*	92.2*	85.8*	79.5*	72.5*	65.5*	59.0*	53.2*	46.3*		30
32		90.4*	86.0*	80.7*	75.2*	69.4*	63.0*	57.4*	51.7*	46.1*	39.6*	32
34		83.8*	80.1*	75.6*	70.9*	65.9*	60.5*	55.3*	50.3*	44.9*	39.4*	34
36		77.6*	74.4*	70.6*	67.2*	62.8*	58.0*	53.2*	48.8*	43.7*	39.2*	36
38			68.9*	66.5*	63.1*	59.3*	55.4*	51.1*	47.0*	42.4*	38.4*	38
40			64.4*	61.9*	59.5*	56.3*	52.9*	49.3*	45.2*	41.1*	37.3*	40
44				54.1*	52.2*	50.4*	47.5*	45.0*	41.9*	38.3*	35.1*	44
48				47.1*	46.2*	44.8*	42.7*	40.8*	38.3*	35.5*	32.7*	48
52					40.3*	39.4*	38.3*	36.7*	35.1*	32.7*	30.3*	52
56						35.1*	34.3*	33.0*	31.6*	29.8*	28.0*	56
60							31.2*	30.3*	29.8*	28.8*	27.4*	60
64								27.3*	26.7*	25.8*	24.8*	64
68									23.8*	23.2*	22.5*	68
72									21.4*	21.1*	20.3*	72
76										18.9*	18.5*	76
80											16.7*	80
84												84
88												88

Note: For values above with “\*”, the superlift counterweight must not leave the ground.



## Load Chart of LJDB

SCE6000A Crawler Crane—LJDB Configuration 7/9												
Boom length 72m, Boom angle 85° , Jib length 24~84m, Superlift radius 16m, Superlift counterweight 250t, Rear counterweight 160t, Carbody counterweight 50t												
Boom length Radius(m)	24	30	36	42	48	54	60	66	72	78	84	Boom length Radius(m)
18	145*	129*										18
20	137*	123*	110*									20
22	127*	116*	105*	94.6*								22
24	118*	109*	99.9*	90.5*	81.5*	73.2*						24
26	110*	102*	94.6*	86.3*	78.7*	71.0*	63.5*					26
28	101*	95.2*	88.7*	82.0*	75.2*	68.2*	61.6*	55.5*				28
30	93.9*	88.5*	83.0*	77.2*	71.8*	65.4*	59.3*	53.9*	48.5*			30
32	87.6*	81.5*	77.4*	73.0*	67.8*	62.6*	57.3*	52.3*	47.2*	41.6*	35.7*	32
34		75.6*	72.1*	68.4*	64.3*	59.7*	54.9*	50.3*	45.8*	41.0*	35.5*	34
36		70.7*	67.5*	63.9*	60.5*	56.8*	52.6*	48.3*	44.2*	39.8*	35.3*	36
38			62.7*	60.0*	57.1*	53.6*	50.2*	46.6*	42.7*	38.6*	34.9*	38
40			58.6*	56.3*	53.9*	50.8*	47.8*	44.3*	41.1*	37.4*	33.9*	40
44				48.9*	47.2*	45.5*	43.2*	40.6*	37.8*	34.8*	31.7*	44
48				42.7*	41.8*	40.3*	38.7*	36.7*	34.7*	32.1*	29.5*	48
52					36.7*	35.8*	34.4*	33.2*	31.4*	29.5*	27.5*	52
56						31.6*	30.9*	29.8*	28.5*	26.8*	25.1*	56
60						28.1*	27.3*	26.6*	25.6*	24.5*	23.1*	60
64							24.3*	23.9*	23.1*	22.1*	21.1*	64
68								21.5*	20.7*	20.1*	19.1*	68
72								19.1*	18.7*	18.1*	17.3*	72
76									16.8*	16.3*	15.6*	76
80										14.7*	14.2*	80
84										13.2*	12.8*	84
88											11.5*	88

Note: For values above with “\*”, the superlift counterweight must not leave the ground.

Unit: t

### Load Chart of LJDB

SCE6000A Crawler Crane—LJDB Configuration 8/9												
Boom length 78m, Boom angle 85° , Jib length 24~84m, Superlift radius 16m, Superlift counterweight 250t, Rear counterweight 160t, Carbody counterweight 50t												
Boom length Radius(m)	24	30	36	42	48	54	60	66	72	78	84	Boom length Radius(m)
18	129*											18
20	122*	110*	98.6*									20
22	114*	104*	94.6*	84.9*								22
24	106*	98.2*	89.8*	81.6*	73.7*							24
26	99.2*	92.3*	85.0*	77.8*	71.0*	64.0*	57.5*					26
28	92.0*	86.1*	80.3*	73.9*	67.8*	61.8*	55.8*	50.2*				28
30	85.4*	80.1*	75.1*	70.0*	64.6*	59.2*	54.0*	49.0*	43.2*			30
32	79.7*	74.4*	70.6*	66.2*	61.4*	56.9*	51.8*	47.5*	42.9*	37.1*		32
34		69.1*	65.8*	62.0*	58.2*	54.2*	49.9*	45.6*	41.4*	36.9*	31.6*	34
36		64.7*	61.7*	58.3*	55.1*	51.6*	47.7*	43.8*	40.1*	36.2*	31.4*	36
38		60.4*	57.3*	54.8*	52.0*	48.6*	45.5*	42.2*	38.8*	35.1*	31.2*	38
40			53.7*	51.1*	48.7*	46.4*	43.3*	40.3*	37.2*	34.0*	30.8*	40
44			46.9*	44.8*	43.1*	41.4*	39.0*	36.9*	34.3*	31.5*	28.9*	44
48				39.4*	38.2*	36.7*	35.2*	33.3*	31.2*	29.1*	26.8*	48
52					33.8*	32.6*	31.3*	30.0*	28.4*	26.6*	24.8*	52
56						28.8*	27.9*	26.9*	25.7*	24.3*	22.6*	56
60							25.7*	24.9*	24.2*	23.3*	22.0*	60
64								22.2*	21.7*	20.8*	20.0*	64
68									19.3*	18.6*	18.0*	68
72									17.4*	16.8*	16.2*	72
76										15.1*	14.5*	76
80											13.0*	80
84											11.7*	84
88												88

Note: For values above with “\*”, the superlift counterweight must not leave the ground.

## Load Chart of LJDB

SCE6000A Crawler Crane—LJDB Configuration 9/9												
Boom length 84m, Boom angle 85° , Jib length 24~84m, Superlift radius 16m, Superlift counterweight 250t, Rear counterweight 160t, Carbody counterweight 50t												
Boom length Radius(m)	24	30	36	42	48	54	60	66	72	78	84	Boom length Radius(m)
18	114*											18
20	108*	98.2*										20
22	102*	93.5*	84.4*	76.1*								22
24	95.8*	88.2*	80.6*	73.1*	66.4*							24
26	89.6*	83.0*	76.8*	70.0*	63.9*	57.7*						26
28	83.3*	77.9*	72.5*	66.9*	61.4*	55.7*	50.3*					28
30	77.9*	72.6*	68.3*	63.3*	58.5*	53.6*	48.9*	43.7*	38.1*			30
32	72.6*	68.0*	63.8*	59.8*	55.5*	51.1*	46.9*	42.8*	37.7*	32.6*		32
34		63.2*	59.9*	56.4*	52.6*	48.8*	45.1*	41.4*	37.4*	32.4*	27.7*	34
36		58.8*	56.2*	53.1*	49.8*	46.7*	43.0*	39.6*	36.4*	32.0*	27.5*	36
38		55.2*	52.3*	49.6*	47.0*	44.3*	41.2*	38.1*	35.1*	31.7*	27.3*	38
40			49.0*	46.6*	44.3*	41.9*	39.2*	36.6*	33.6*	30.6*	27.0*	40
44			42.8*	40.9*	39.5*	37.4*	35.3*	33.3*	30.9*	28.4*	25.9*	44
48				35.9*	34.8*	33.4*	31.7*	29.9*	28.2*	26.1*	24.1*	48
52					30.8*	29.7*	28.4*	27.2*	25.6*	23.9*	22.1*	52
56					27.4*	26.3*	25.3*	24.3*	23.1*	21.7*	20.2*	56
60						23.2*	22.6*	21.7*	20.8*	19.6*	18.4*	60
64							20.2*	19.4*	18.7*	17.7*	16.7*	64
68								17.4*	16.7*	16.0*	15.2*	68
72								15.5*	14.9*	14.3*	13.6*	72
76									13.4*	12.8*	12.2*	76
80										11.6*	11.0*	80
84										10.3*	9.7*	84
88											8.7*	88

Note: For values above with “\*”, the superlift counterweight must not leave the ground.

## Boom Combination in ZH

Boom Combination in ZH					
Boom length (m)	Power boom				
	6m/(ZH6)	12m/(ZH4A)	12m/(ZH8A)	12m/(ZH8B)	12m/(ZH4B)
48	-	1	-	-	1
54	1	1	-	-	1
60	-	1	1	-	1
66	1	1	1	-	1
72	-	1	1	1	1
78	1	1	1	1	1
84	-	1	1	2	1

Attention: If the boom length is 78m and more, the crane must boom up from side by side erection outrigger, otherwise, the crane may tip over !

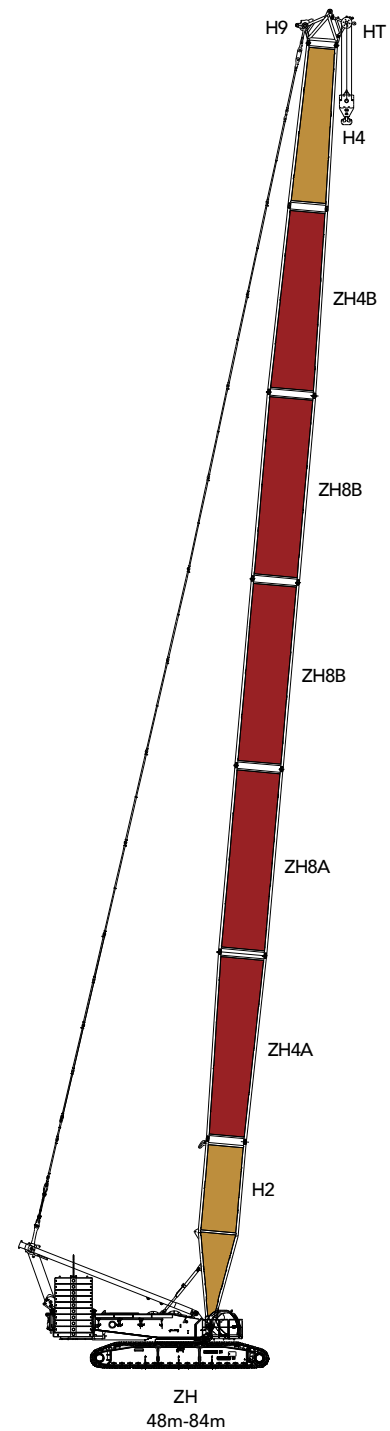

# Working Radius in ZH

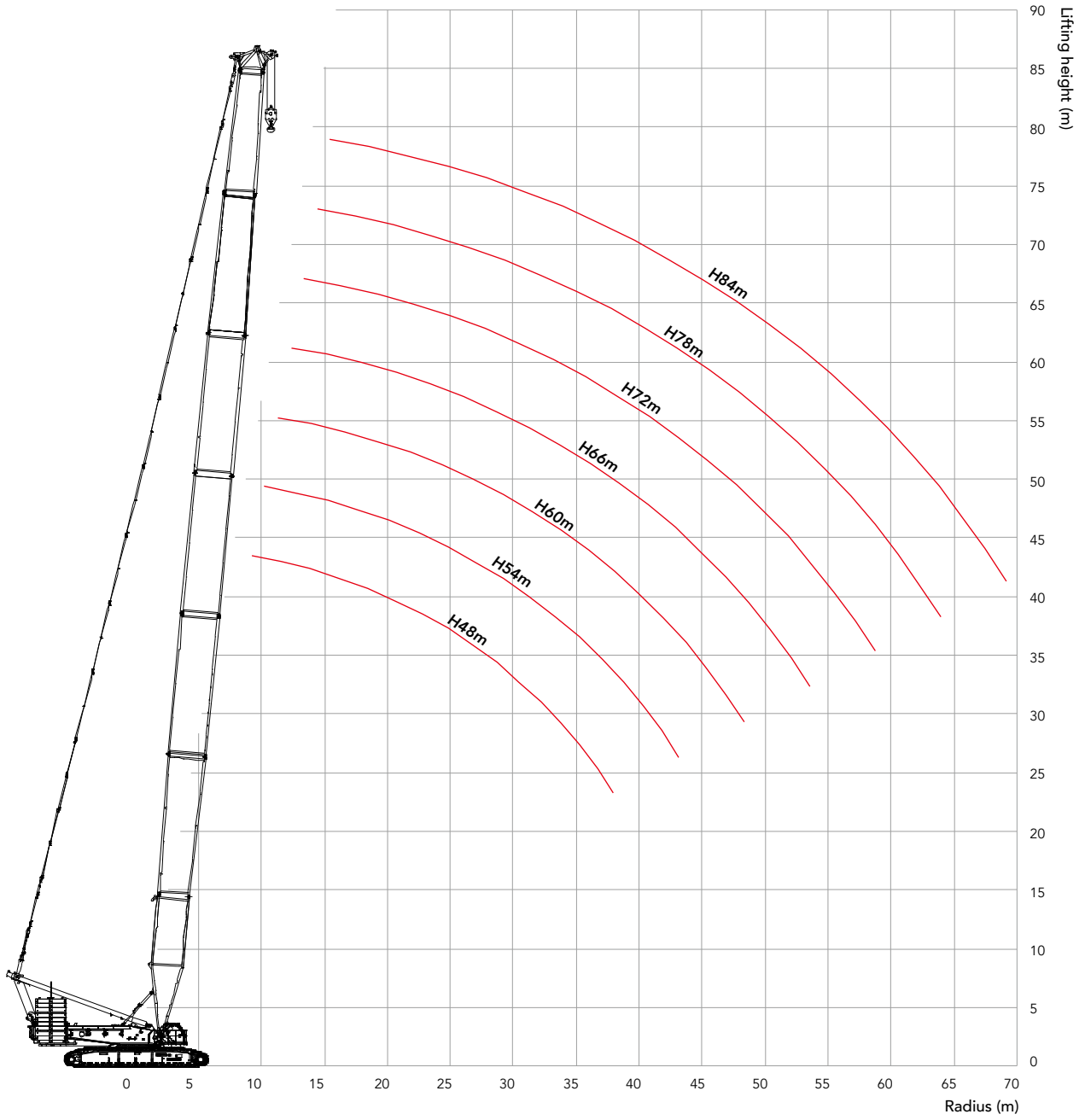

Unit: t

## Load Chart of ZH

SCE6000A Crawler Crane- ZH Configuration								
Boom length 48m~84m, Rear counterweight 200t, Carbody counterweight 50t								
Boom length (m) Radius(m)	48	54	60	66	72	78	84	Boom length (m) Radius(m)
8	437							8
9	382	362	344					9
10	338	322	307	293	280			10
11	303	290	277	265	255	244	234	11
12	274	263	252	242	233	223	215	12
14	229	221	213	205	198	190	183	14
16	196	189	183	177	171	165	159	16
18	171	165	160	155	150	144	140	18
20	150	146	141	137	132	128	124	20
22	134	130	126	122	118	114	110	22
24	118	116	113	109	106	102	99.7	24
26	104	104	102	99.3	96.3	92.9	90.0	26
28	93.8	93.4	93.0	90.1	87.5	84.4	81.7	28
30	84.3	84.0	83.6	82.2	79.8	76.8	74.3	30
32	76.2	75.9	75.6	74.7	73.0	70.2	67.9	32
34	69.1	68.9	68.6	67.7	66.9	64.3	62.1	34
36	62.9	62.7	62.5	61.6	61.0	59.0	57.0	36
38	57.3	57.2	57.0	56.2	55.6	54.3	52.3	38
40	52.3	52.3	52.2	51.4	50.8	49.7	48.1	40
44	43.4	43.8	43.8	43.1	42.6	41.4	40.7	44
48		36.6	36.8	36.2	35.8	34.7	33.9	48
52			30.9	30.4	30.0	29.0	28.3	52
56				25.4	25.1	24.1	23.4	56
60					20.8	19.9	19.2	60
64					16.9	16.2	15.6	64
68						12.8	12.3	68
72							9.4	72

## Boom Combination in ZHDB

Boom Combination in ZHDB								
Boom length (m)	Boom insert			Power boom				
	6m/ (H6)	12mA/ (H8A)	12mA/ (H8B)	12m/ (ZH4A)	12m/ (ZH8A)	12m/ (ZH8B)	6m/ (ZH6)	12m/ (ZH4B)
48	-	-	-	1	-	-	-	1
54	-	-	-	1	-	-	1	1
60	-	-	-	1	1	-	-	1
66	-	-	-	1	1	-	1	1
72	-	-	-	1	1	1	-	1
78	-	-	-	1	1	1	1	1
84	-	-	-	1	1	2	-	1
90	-	-	-	1	1	2	1	1
96	-	-	-	1	1	2	2	1
102*	1	-	-	1	1	2	2	1
108*	2	-	-	1	1	2	2	1
114*	1	1	-	1	1	2	2	1
120*	2	1	-	1	1	2	2	1
126*	1	1	1	1	1	2	2	1
132*	2	1	1	1	1	2	2	1
138*	1	1	2	1	1	2	2	1

Note: For boom combinations of 102m~138m, marked with "\*", the mid-point suspension cable must be used, otherwise, the boom system may break.

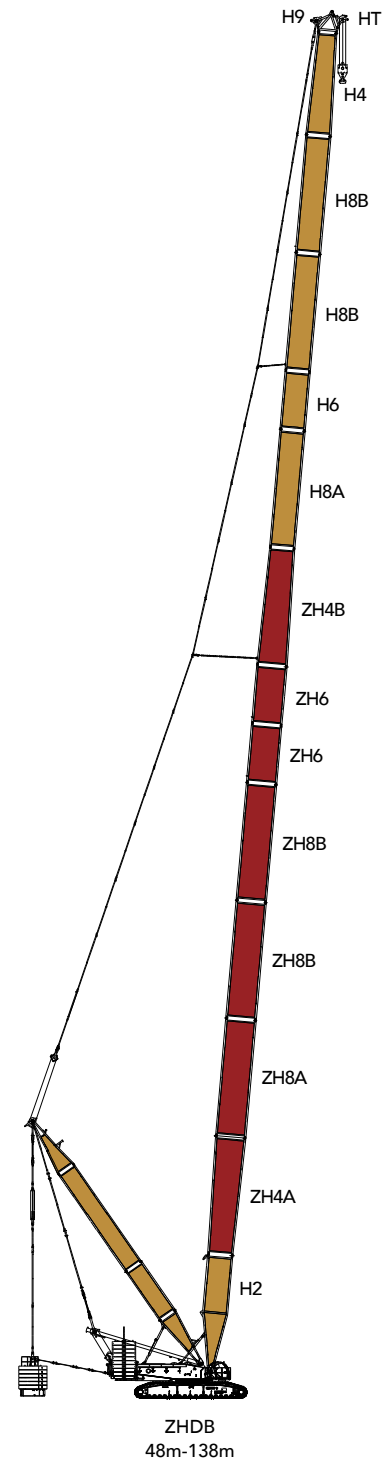

## Working Radius in ZHDB

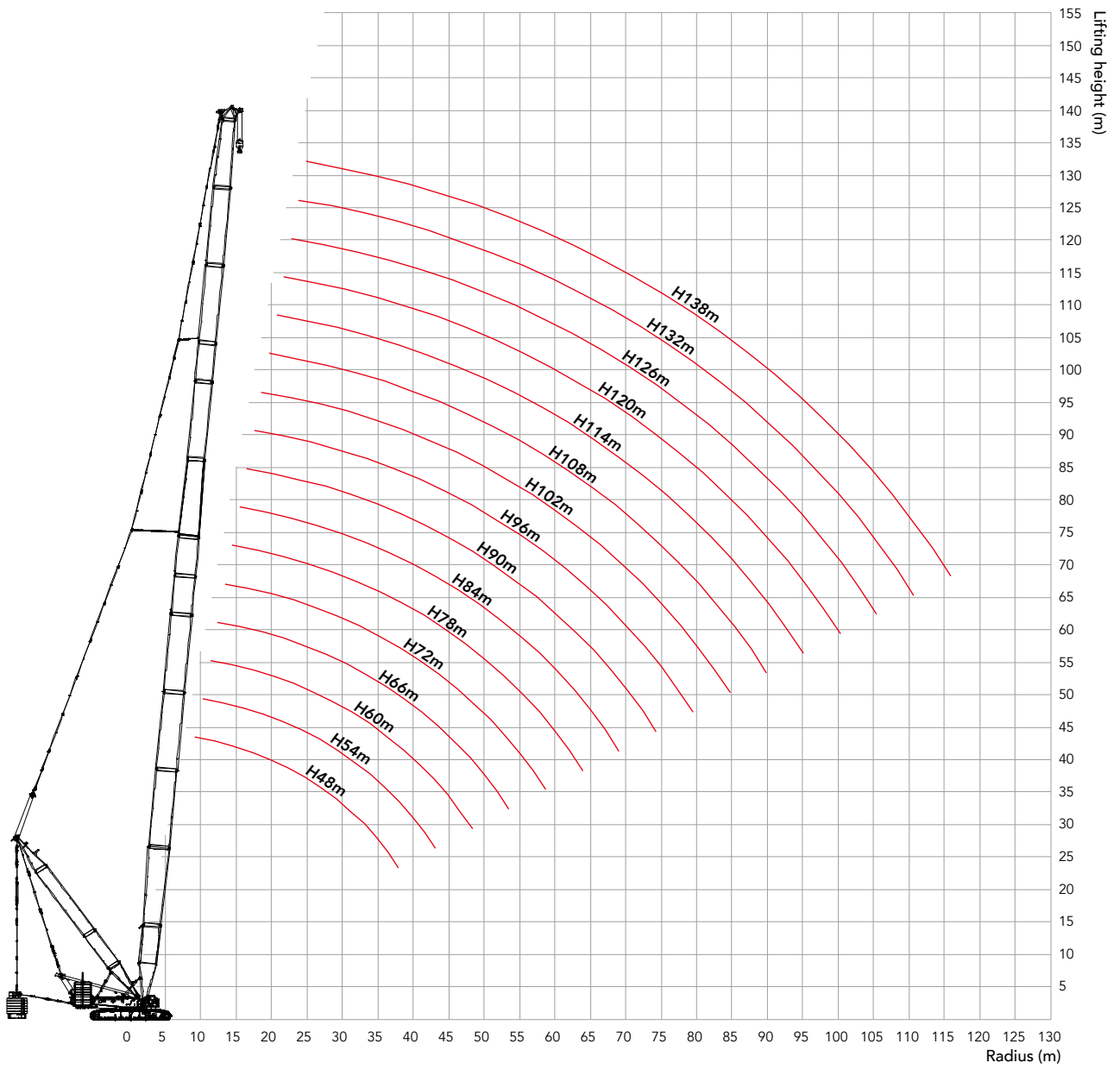



## Load Chart of ZHDB

SCE6000A Crawler Crane- ZHDB Configuration																	
Boom length 48m~138m, Superlift radius 16m, Superlift counterweight 250t, Rear counterweight 160t, Carbody counterweight 50t																	
Boom length Radius(m)	48	54	60	66	72	78	84	90	96	102	108	114	120	126	132	138	Boom length Radius(m)
8	600*																8
9	600*	489*	455*														9
10	600*	489*	455*	421*	353*												10
11	600	523*	455*	421*	387*	353*	318*										11
12	600	523	455*	421*	387*	353*	318*	284*	284*								12
14	588	523	455	421	387*	353*	318*	284*	284*	249*	222*	198*	174*				14
16	506	501	455	421	387	353	318*	284*	284*	249*	222*	199*	175*	153*	135*	119*	16
18	443	442	430	419	387	353	318	284*	284*	249*	222*	199*	175*	153*	136*	118*	18
20	393	393	385	376	367	353	318	284	284	249*	223*	199*	175*	153*	135*	117*	20
22	353	353	348	340	332	325	317	284	284	249	223	199*	175*	154*	134*	116*	22
24	316	316	316	310	304	297	290	284	277	249	222	199	175*	153*	133*	115*	24
26	284	284	284	284	279	273	267	261	255	249	222	199	175	153*	132*	114*	26
28	258	258	258	257	257	252	247	242	236	232	221	199	175	152*	131*	113*	28
30	236	236	236	235	235	234	230	225	220	215	211	199	174	150	129*	112*	30
32	217	217	217	216	216	215	214	209	205	201	197	194	173	149	128*	111*	32
34	200	200	200	200	199	198	198	196	192	188	185	181	171	148	127	109*	34
36	186	186	186	185	185	184	183	182	180	177	173	170	167	146	126	108*	36
38	173	173	173	173	172	171	171	169	168	166	163	160	157	145	124	107	38
40	161	162	162	161	161	160	159	158	157	156	154	151	148	144	123	106	40
44	142	142	142	142	141	140	140	139	138	137	136	135	132	130	120	103	44
48		126	126	126	126	125	124	123	122	121	120	120	119	117	115	101	48
52			113	112	112	111	111	110	108	108	107	106	106	105	104	99.1	52
56				101	101	100	100	98.8	97.7	97.1	96.4	95.7	94.9	94.6	93.7	93.0	56
60					91.6	90.8	90.3	89.2	88.0	87.4	86.8	86.1	85.3	84.9	84.1	83.6	60
64					83.0	82.3	81.9	80.8	79.6	79.1	78.4	77.7	76.9	76.6	75.7	75.3	64
68						74.8	74.4	73.4	72.3	71.7	71.1	70.4	69.6	69.3	68.4	67.9	68
72							67.8	66.8	65.7	65.2	64.6	63.9	63.1	62.8	61.9	61.5	72
76								60.9	59.9	59.4	58.8	58.1	57.4	57.0	56.2	55.7	76
80								55.5	54.6	54.1	53.6	52.9	52.2	51.8	51.0	50.5	80
84									49.7	49.4	48.8	48.2	47.5	47.1	46.3	45.9	84
88										45.0	44.5	43.9	43.2	42.9	42.1	41.6	88
92											40.6	40.0	39.3	39.0	38.2	37.8	92
96												36.9	36.4	35.7	35.4	34.7	96
100														33.0	32.4	31.4	100
104															29.3	29.1	104
108																26.3	108
112																22.9	112
116																20.4	116
120																	120

## Boom Combination in ZLJ

Boom Combination in ZLJ								
Boom length (m)	Power boom				Jib insert			
	12m/ ZH4A	12m/ ZH4B	12m/ ZH8A	6m/ ZH6	6m/ LJ6A	6m/ LJ6B	12m/ LJ7A	12m/ LJ7B
24	-	-	-	-	1	-	-	-
30	-	-	-	-	2	-	-	-
36	-	-	-	-	1	-	1	-
42	-	-	-	-	2	-	1	-
48	1	1	-	-	1	-	2	-
54	1	1	-	1	2	-	2	-
60	1	1	1	-	2	1	2	-
66*	-	-	-	-	2	-	2	1
72*	-	-	-	-	2	1	2	1

For LJ configuration: boom length 48m~60m, jib length 24m~72m, Boom angle: 65° , 75° , 85° ,  
Longest boom combination: 54m+72m

Note: For combinations of 66m~72m, marked with "\*", the mid-point suspension cable must be used for jib. The use of mid-point suspension cable must be strictly in accordance with the Operation Manual.

Attention: For LJ configuration, the crane must boom up strictly in accordance with the LJ Erection and Lowering Table in Operation Manual, otherwise the crane may tip over!

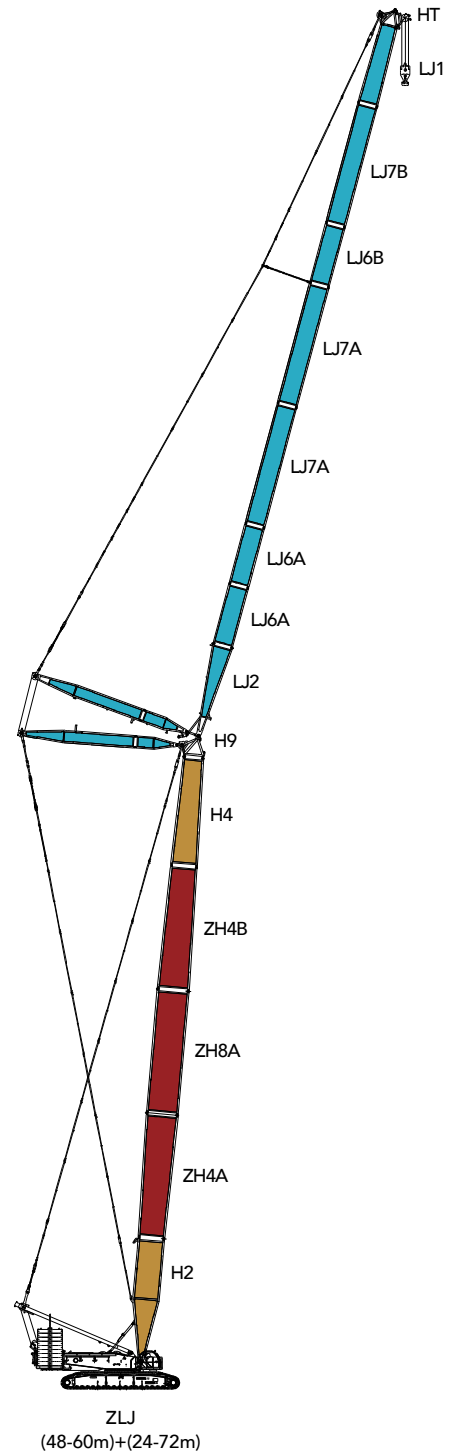

# Working Radius in ZLJ

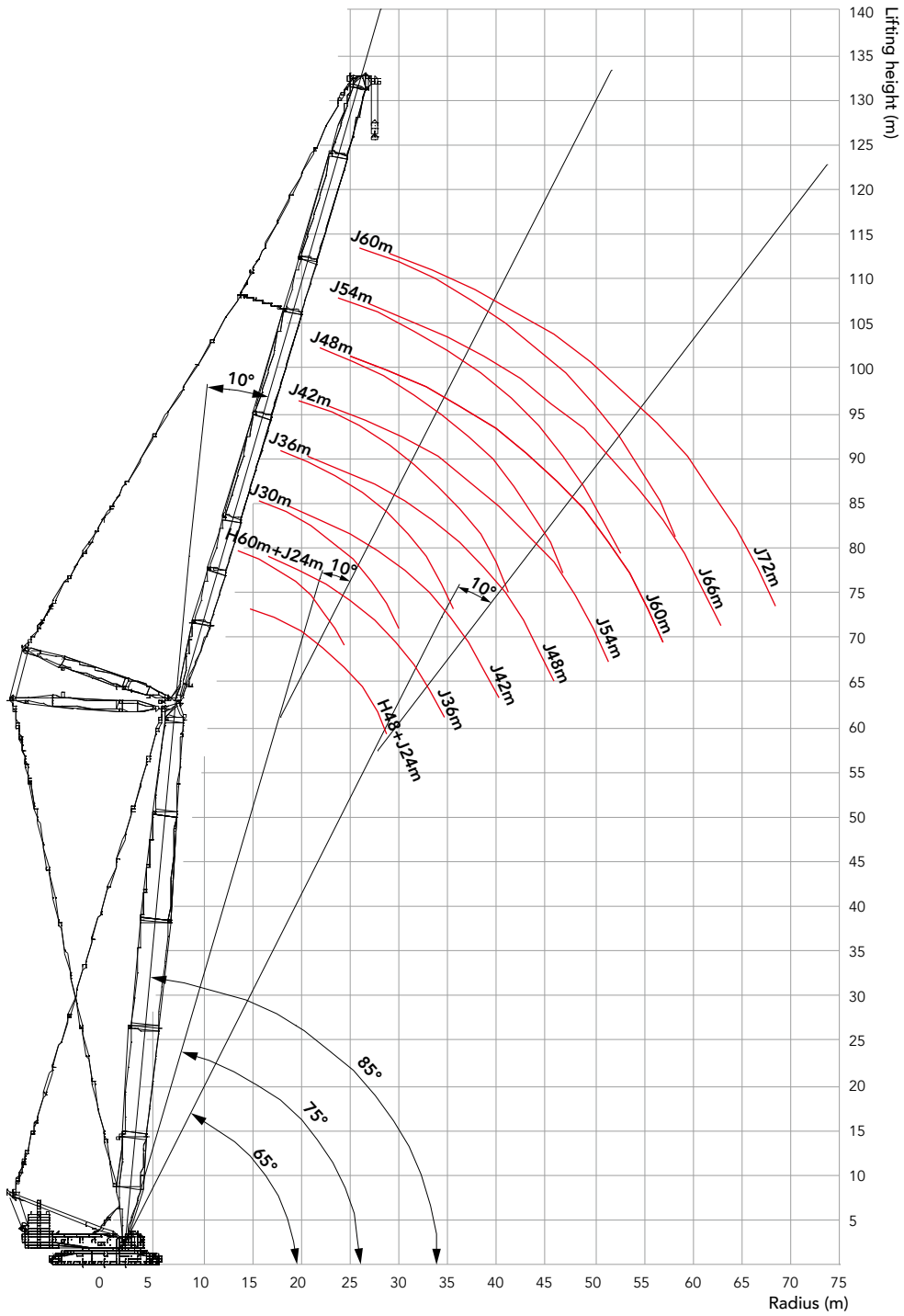

Unit: t

## Load Chart of ZLJ

SCE6000A Crawler Crane- ZLJ Configuration 1/3										
Boom length 48m, Boom angle 85°, Jib length 24m~72m, Rear counterweight 200t, Carbody counterweight 50t										
Boom length Radius(m)	24	30	36	42	48	54	60	66	72	Boom length Radius(m)
16	187	181								16
18	167	162	157							18
20	150	146	142	138						20
22	137	133	129	126	122	119				22
24	125	122	119	115	112	109	106			24
26	116	112	109	106	104	101	98.4	94.1		26
28	107	104	102	99.0	96.5	93.8	91.3	89.2	79.3	28
30	100	97.5	95.0	92.2	89.9	87.4	85.1	83.1	78.9	30
32		91.2	88.9	86.2	84.0	81.7	79.5	77.6	75.5	32
34		85.7	83.4	80.9	78.8	76.6	74.5	72.8	70.8	34
36			78.6	76.1	74.2	72.0	70.1	68.4	66.5	36
38			74.2	71.8	70.0	67.9	66.0	64.4	62.6	38
40			69.8	67.9	66.1	64.2	62.3	60.8	59.1	40
44				60.9	59.5	57.6	55.9	54.5	52.9	44
48					53.8	52.1	50.5	49.2	47.6	48
52					47.9	47.4	45.8	44.6	43.1	52
56						42.6	41.8	40.7	39.2	56
60							37.9	37.2	35.8	60
64							34.2	34.0	32.7	64
68								30.7	30.0	68
72									27.3	72
76									24.7	76

**Load Chart of ZLJ****SCE6000A Crawler Crane- ZLJ Configuration 2/3**

Boom length 54m, Boom angle 85°, Jib length 24m~72m, Rear counterweight 200t, Carbody counterweight 50t

Boom length Radius(m)	24	30	36	42	48	54	60	66	72	Boom length Radius(m)
16	180									16
18	161	156	152							18
20	145	141	137	133						20
22	132	129	125	122	118					22
24	122	118	115	112	109	106	103			24
26	112	109	106	103	100	98.0	95.4	89.7		26
28	104	101	99.0	96.1	93.6	91.0	88.5	86.4	76.0	28
30	97.6	94.7	92.3	89.6	87.3	84.8	82.5	80.5	75.7	30
32		88.7	86.4	83.8	81.7	79.3	77.2	75.3	73.2	32
34		83.3	81.2	78.7	76.6	74.4	72.4	70.6	68.6	34
36		78.6	76.4	74.1	72.1	70.0	68.1	66.4	64.5	36
38			72.2	69.9	68.1	66.0	64.1	62.6	60.7	38
40			68.4	66.1	64.4	62.4	60.6	59.1	57.3	40
44				59.6	57.9	56.1	54.4	53.0	51.3	44
48					52.4	50.7	49.1	47.8	46.2	48
52					47.7	46.1	44.6	43.4	41.9	52
56						42.1	40.6	39.5	38.0	56
60							37.2	36.1	34.7	60
64							32.5	33.1	31.7	64
68								29.0	29.1	68
72									26.2	72
76									23.0	76

Unit: t

## Load Chart of ZLJ

SCE6000A Crawler Crane- ZLJ Configuration 3/3								
Boom length 60m, Boom angle 85°, Jib length 24m~60m, Rear counterweight 200t, Carbody counterweight 50t								
Boom length Radius(m)	24	30	36	42	48	54	60	Boom length Radius(m)
16	173							16
18	155	151						18
20	141	136	133	129				20
22	128	124	121	118	114			22
24	118	114	111	108	105	102		24
26	109	106	103	100	97.7	94.9	92.3	26
28	101	98.6	96.1	93.2	90.8	88.2	85.7	28
30	94.7	92.0	89.6	86.9	84.7	82.2	80.0	30
32		86.1	83.9	81.4	79.3	77.0	74.8	32
34		80.9	78.9	76.4	74.4	72.2	70.2	34
36		76.3	74.3	72.0	70.1	68.0	66.0	36
38			70.2	67.9	66.1	64.1	62.2	38
40			66.5	64.3	62.5	60.6	58.8	40
44				57.9	56.3	54.5	52.8	44
48				52.6	51.0	49.3	47.7	48
52					46.5	44.8	43.3	52
56						40.9	39.4	56
60						35.1	36.1	60
64							31.2	64

## Boom Combination in ZLJDB

### Boom Combination in ZLJDB

Boom length (m)	Power boom					Jib insert			
	12m/ ZH4A	12m/ ZH4B	12m/ ZH8A	12m/ ZH8B	6m/ ZH6	6m/ LJ6A	6m/ LJ6B	12m/ LJ7A	12m/ LJ7B
24	-	-	-	-	-	1	-	-	-
30	-	-	-	-	-	2	-	-	-
36	-	-	-	-	-	1	-	1	-
42	-	-	-	-	-	2	-	1	-
48	1	1	-	-	-	1	-	2	-
54	1	1	-	-	1	2	-	2	-
60	1	1	1	-	-	2	1	2	-
66*	1	1	1	-	1	2	-	2	1
72*	1	1	1	1	-	2	1	2	1
78*	1	1	1	1	1	2	-	2	2
84*	1	1	1	2	-	2	1	2	2

For LJDB configuration: boom length 48m~84m, jib length 24m~84m, boom angle: 65° , 75° , 85°  
Note: For combinations of 66m~84m, marked with "\*", the mid-point suspension cable must be used for jib. The use of mid-point suspension cable must be strictly in accordance with the Operation Manual.

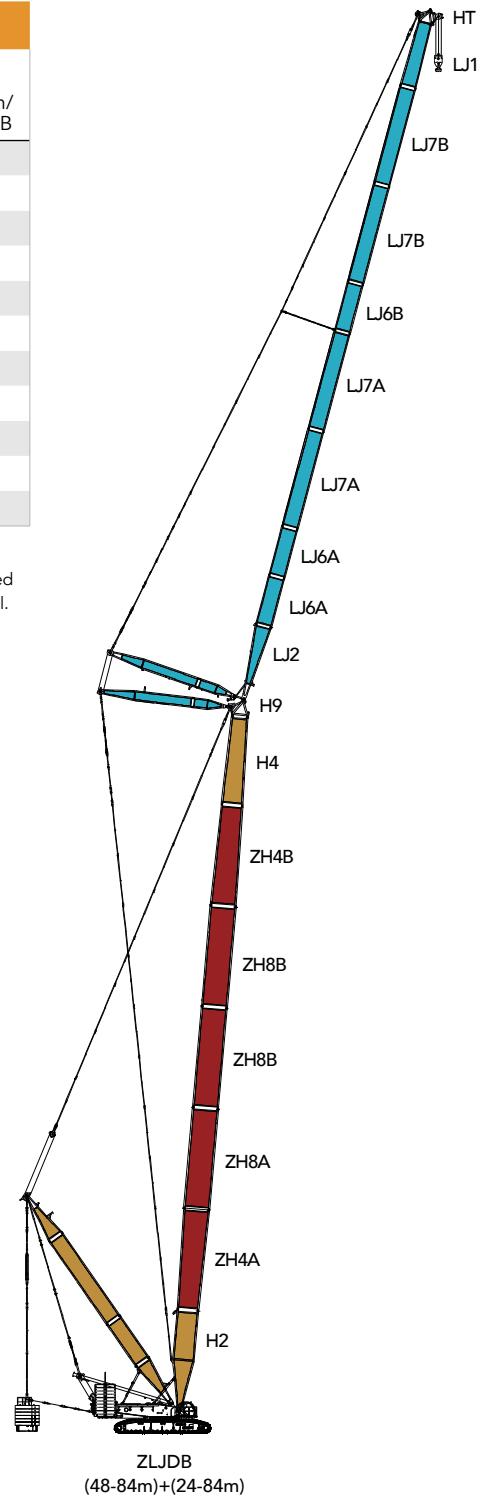

## Working Radius in ZLJDB

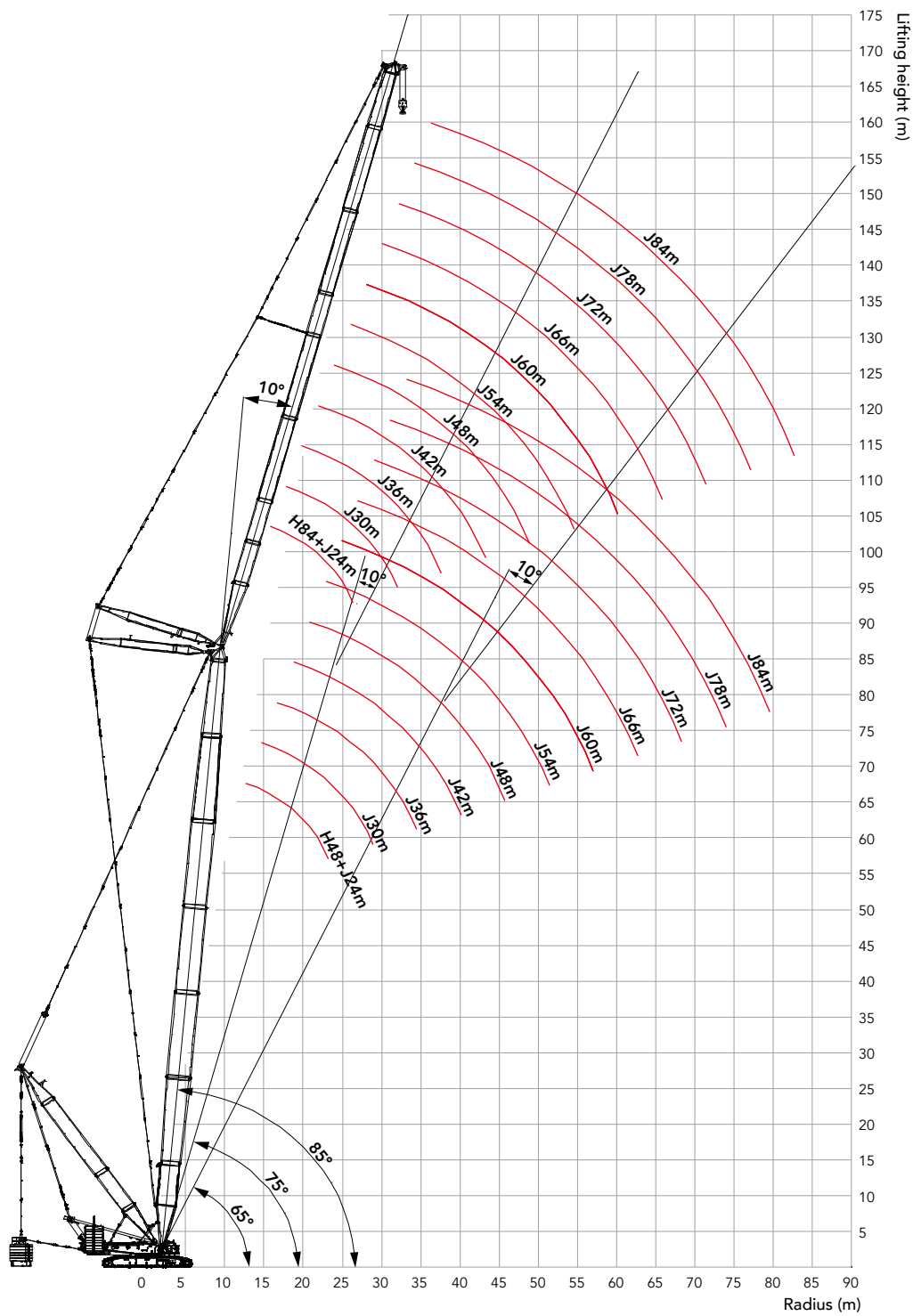



**Load Chart of ZLJDB**

SCE6000A Crawler Crane- ZLJDB Configuration 1/7												
Boom length 48m, Boom angle 85°, Jib length 24m~84m, Superlift radius 16m, Superlift counterweight 250t, Rear counterweight 160t, Carbody counterweight 50t												
Boom length (m) Radius(m)	24	30	36	42	48	54	60	66	72	78	84	Boom length (m) Radius(m)
16	266*	251*										16
18	250*	248*	223*									18
20	225*	224*	222*	191*								20
22	204*	203*	202*	189*	162*	133*						22
24	186*	185*	185*	183*	161*	133*	110*					24
26	172*	171*	169*	169*	161*	133*	110*	94.7*				26
28	158*	158*	157*	156*	156*	132*	109*	94.4*	79.7*			28
30	147*	147*	145*	145*	144*	131*	109*	94.0*	79.4*	66.6*	56.5*	30
32		136*	136*	135*	134*	130*	108*	93.5*	79.0*	66.1*	56.1*	32
34		129*	128*	127*	126*	125*	107*	93.0*	78.6*	65.6*	55.7*	34
36			121*	119*	118*	118*	106*	92.4*	78.1*	65.1*	55.2*	36
38			113*	113*	112*	111*	105*	91.8*	77.6*	64.6*	54.8*	38
40			108*	107*	106*	104*	104*	91.1*	77.1*	64.1*	54.3*	40
44				96.7*	96.1*	94.8*	93.8*	89.7*	76.0*	63.0*	53.4*	44
48					86.7*	86.0*	84.6*	83.9*	74.9*	60.9*	52.4*	48
52					79.4*	79.0*	75.5*	76.6*	73.7*	55.8*	51.5*	52
56						72.4*	67.6*	70.5*	69.9*	50.8*	50.5*	56
60							61.2*	65.3*	64.1*	46.7*	49.6*	60
64							55.9*	60.4*	59.4*	42.8*	48.8*	64
68								56.0*	55.2*	38.9*	45.1*	68
72									50.6*	35.7*	41.7*	72
76									46.5*	32.1*	38.0*	76
80										29.7*	34.9*	80
84											32.0*	84
88											32.0*	88

Unit: t

## Load Chart of ZLJDB

SCE6000A Crawler Crane- ZLJDB Configuration 2/7												
Boom length 54m, Boom angle 85°, Jib length 24m~84m, Superlift radius 16m, Superlift counterweight 250t, Rear counterweight 160t, Carbody counterweight 50t												
Boom length Radius(m)	24	30	36	42	48	54	60	66	72	78	84	Boom length Radius(m)
16	266*											16
18	237*	236*	218*									18
20	213*	210*	209*	186*								20
22	192*	191*	189*	185*	153*							22
24	176*	174*	173*	172*	153*	127*	105*					24
26	162*	161*	160*	159*	152*	126*	105*	90.6*				26
28	149*	148*	147*	146*	146*	126*	104*	90.4*	76.7*			28
30	139*	137*	138*	136*	135*	125*	104*	90.1*	76.4*	64.1*		30
32		130*	128*	127*	126*	124*	103*	89.7*	76.1*	63.8*	54.1*	32
34		121*	120*	119*	118*	117*	103*	89.3*	75.6*	63.4*	53.8*	34
36		114*	113*	112*	111*	110*	102*	88.8*	75.4*	63.0*	53.4*	36
38			107*	106*	105*	103*	101*	88.3*	75.0*	62.5*	53.0*	38
40			101*	100*	99.6*	98.1*	97.0*	87.7*	74.5*	62.1*	52.6*	40
44				90.9*	90.1*	88.7*	87.6*	86.0*	73.6*	61.1*	51.8*	44
48					81.6*	80.6*	79.4*	78.1*	72.6*	60.1*	51.0*	48
52					74.7*	73.6*	72.4*	71.7*	70.4*	56.2*	50.1*	52
56						67.8*	66.3*	65.5*	64.7*	51.4*	49.2*	56
60							61.4*	60.6*	59.8*	46.7*	48.5*	60
64							56.6*	56.5*	55.1*	42.9*	47.6*	64
68								51.7*	51.1*	39.2*	45.6*	68
72									46.4*	36.1*	41.8*	72
76									42.1*	32.6*	38.6*	76
80										29.6*	35.1*	80
84											32.3*	84
88											29.4*	88

**Load Chart of ZLJDB**

SCE6000A Crawler Crane- ZLJDB Configuration 3/7												
Boom length 60m, Boom angle 85°, Jib length 24m~84m, Superlift radius 16m, Superlift counterweight 250t, Rear counterweight 160t, Carbody counterweight 50t												
Boom length (m) Radius(m)	24	30	36	42	48	54	60	66	72	78	84	Boom length (m) Radius(m)
16	263*											16
18	232*	231*										18
20	208*	206*	205*	176*								20
22	187*	186*	185*	176*	146*							22
24	171*	170*	169*	169*	146*	121*						24
26	158*	157*	155*	154*	145*	121*	101*	87.2*				26
28	145*	144*	143*	142*	142*	120*	100*	87.0*	74.0*			28
30	136*	135*	133*	132*	132*	120*	100*	86.8*	73.8*	62.1*		30
32		125*	125*	124*	123*	119*	100*	86.5*	73.5*	61.8*	52.5*	32
34		118*	116*	115*	114*	114*	99.4*	86.1*	73.3*	61.5*	52.2*	34
36		111*	110*	109*	108*	106*	98.7*	85.7*	72.9*	61.1*	51.9*	36
38			104*	102*	102*	100*	98.0*	85.2*	72.6*	60.7*	51.5*	38
40			98.6*	97.7*	96.3*	95.4*	94.6*	84.7*	72.2*	60.3*	51.2*	40
44				87.5*	87.3*	85.7*	84.5*	83.5*	71.4*	59.5*	50.5*	44
48				80.0*	78.8*	77.9*	76.7*	75.5*	70.4*	58.6*	49.7*	48
52					72.3*	71.3*	69.9*	69.1*	68.3*	56.1*	48.9*	52
56						65.6*	64.1*	63.4*	62.8*	51.4*	48.1*	56
60						60.1*	59.5*	58.6*	57.4*	47.0*	47.4*	60
64							54.3*	53.9*	52.7*	43.1*	46.6*	64
68								48.7*	48.2*	39.4*	44.1*	68
72									43.7*	36.4*	40.9*	72
76									39.8*	32.9*	37.8*	76
80										30.1*	34.9*	80
84											32.1*	84
88											29.3*	88

Unit: t

## Load Chart of ZLJDB

SCE6000A Crawler Crane- ZLJDB Configuration 4/7												
Boom length 66m, Boom angle 85°, Jib length 24m~84m, Superlift radius 16m, Superlift counterweight 250t, Rear counterweight 160t, Carbody counterweight 50t												
Boom length Radius(m)	24	30	36	42	48	54	60	66	72	78	84	Boom length Radius(m)
16	257*											16
18	227*	226*										18
20	203*	201*	197*									20
22	183*	182*	182*	163*	137*							22
24	167*	166*	165*	163*	136*	114*						24
26	153*	152*	151*	150*	136*	114*	96.0*					26
28	142*	140*	140*	138*	135*	114*	95.8*	83.0*				28
30	132*	130*	130*	128*	128*	113*	95.5*	82.8*	70.5*	59.5*		30
32		121*	121*	120*	119*	112*	95.0*	82.6*	70.3*	59.2*	50.5*	32
34		114*	113*	112*	111*	110*	94.5*	82.3*	70.1*	59.0*	50.3*	34
36		108*	106*	105*	104*	103*	93.9*	81.9*	69.8*	58.7*	50.0*	36
38			101*	99.6*	99.0*	97.5*	93.2*	81.4*	69.5*	58.4*	49.7*	38
40			95.3*	94.2*	93.3*	92.3*	91.0*	81.0*	69.1*	58.0*	49.4*	40
44				84.9*	84.0*	83.0*	82.3*	79.8*	68.4*	57.3*	48.8*	44
48				77.2*	76.2*	75.6*	74.3*	73.1*	66.5*	56.4*	48.1*	48
52					70.0*	68.8*	67.5*	66.7*	64.6*	55.5*	47.4*	52
56						63.0*	62.0*	61.2*	59.1*	51.4*	46.6*	56
60						56.8*	56.6*	55.5*	54.2*	47.1*	45.9*	60
64							50.6*	50.2*	49.1*	43.4*	44.7*	64
68								45.3*	44.8*	39.8*	41.3*	68
72								40.6*	40.5*	36.3*	38.2*	72
76									36.5*	33.4*	35.0*	76
80										30.2*	32.2*	80
84											29.5*	84
88											27.1*	88

**Load Chart of ZLJDB**

SCE6000A Crawler Crane- ZLJDB Configuration 5/7												
Boom length 72m, Boom angle 85°, Jib length 24m~84m, Superlift radius 16m, Superlift counterweight 250t, Rear counterweight 160t, Carbody counterweight 50t												
Boom length (m) Radius(m)	24	30	36	42	48	54	60	66	72	78	84	Boom length (m) Radius(m)
18	222*	219*										18
20	197*	198*	183*									20
22	179*	178*	177*	153*								22
24	162*	161*	161*	152*	129*	108*						24
26	150*	148*	147*	147*	128*	108*	91.6*					26
28	138*	137*	136*	135*	127*	108*	91.4*	79.4*				28
30	128*	127*	126*	125*	124*	107*	91.1*	79.3*	67.6*			30
32	120*	118*	118*	117*	116*	107*	90.7*	79.1*	67.5*	57.0*	48.7*	32
34		111*	110*	109*	108*	106*	90.4*	78.8*	67.3*	56.8*	48.5*	34
36		105*	103*	102*	101*	100*	89.8*	78.4*	67.0*	56.6*	48.3*	36
38			98.2*	97.0*	96.1*	94.5*	89.1*	78.0*	66.8*	56.3*	48.1*	38
40			92.9*	91.8*	90.6*	89.5*	88.4*	77.5*	66.4*	56.0*	47.8*	40
44				82.4*	81.7*	80.6*	79.6*	76.4*	65.7*	55.3*	47.2*	44
48				75.1*	74.2*	72.8*	71.8*	70.7*	64.8*	54.5*	46.6*	48
52					67.4*	66.5*	65.5*	64.5*	61.4*	53.7*	45.9*	52
56						61.0*	59.8*	58.4*	56.3*	52.1*	45.2*	56
60						54.5*	53.8*	52.8*	51.3*	47.8*	44.5*	60
64							47.8*	47.4*	46.5*	43.6*	42.6*	64
68								42.8*	42.2*	40.1*	39.3*	68
72									38.5*	38.1*	36.6*	72
76										34.7*	33.8*	76
80											30.7*	80
84											28.3*	84
88												88

Unit: t

## Load Chart of ZLJDB

SCE6000A Crawler Crane- ZLJDB Configuration 6/7												
Boom length 78m, Boom angle 85°, Jib length 24m~84m, Superlift radius 16m, Superlift counterweight 250t, Rear counterweight 160t, Carbody counterweight 50t												
Boom length Radius(m)	24	30	36	42	48	54	60	66	72	78	84	Boom length Radius(m)
18	218*											18
20	194*	193*	167*									20
22	174*	174*	166*	141*								22
24	159*	157*	157*	140*	119*							24
26	146*	145*	144*	139*	119*	101*	86.5*					26
28	135*	134*	133*	132*	118*	101*	86.3*	75.0*				28
30	126*	124*	123*	122*	117*	100*	86.0*	74.8*	64.0*			30
32	117*	116*	115*	113*	112*	100*	85.6*	74.6*	63.9*	54.4*		32
34		109*	108*	106*	105*	99.3*	85.0*	74.4*	63.7*	54.2*	46.3*	34
36		103*	101*	100*	99.1*	98.2*	84.4*	74.0*	63.5*	54.0*	46.1*	36
38		96.4*	95.4*	94.3*	93.2*	92.4*	83.7*	73.6*	63.2*	53.7*	45.9*	38
40			90.5*	89.4*	88.0*	87.0*	82.9*	73.1*	62.9*	53.5*	45.7*	40
44			81.9*	80.5*	79.6*	78.3*	77.2*	71.9*	62.2*	52.8*	45.1*	44
48				72.7*	71.9*	70.9*	70.1*	67.1*	61.2*	52.1*	44.5*	48
52					66.0*	64.6*	63.2*	60.8*	58.0*	51.3*	43.9*	52
56						57.6*	56.4*	55.0*	53.0*	49.6*	43.2*	56
60							51.3*	50.7*	49.6*	48.3*	45.8*	60
64								45.2*	44.5*	43.6*	42.0*	64
68									40.1*	39.6*	38.3*	68
72									36.0*	35.7*	34.7*	72
76										32.5*	31.6*	76
80											29.0*	80
84											26.2*	84
88												88

**Load Chart of ZLJDB**

SCE6000A Crawler Crane- ZLJDB Configuration 7/7												
Boom length 84m, Boom angle 85°, Jib length 24m~84m, Superlift radius 16m, Superlift counterweight 250t, Rear counterweight 160t, Carbody counterweight 50t												
Boom length (m) Radius(m)	24	30	36	42	48	54	60	66	72	78	84	Boom length (m) Radius(m)
18	210*											18
20	190*	178*										20
22	171*	170*	152*	131*								22
24	156*	155*	150*	130*	112*							24
26	142*	141*	141*	129*	111*	95.8*						26
28	132*	131*	130*	127*	110*	95.4*	81.6*					28
30	122*	121*	120*	119*	109*	94.8*	81.3*	71.0*	61.0*			30
32	114*	113*	112*	111*	108*	94.0*	80.9*	70.8*	60.9*	51.9*		32
34		106*	105*	104*	103*	93.0*	80.3*	70.5*	60.8*	51.8*	44.3*	34
36		99.8*	99.2*	98.0*	96.8*	91.9*	79.7*	70.1*	60.5*	51.6*	44.1*	36
38		94.5*	93.2*	92.5*	91.1*	90.3*	78.9*	69.6*	60.3*	51.4*	43.9*	38
40			88.5*	87.1*	86.0*	85.1*	78.1*	69.1*	59.9*	51.1*	43.7*	40
44			79.4*	78.5*	77.1*	76.2*	74.2*	67.9*	59.1*	50.5*	43.2*	44
48				71.3*	70.2*	68.9*	66.9*	63.9*	58.2*	49.7*	42.7*	48
52					63.7*	62.0*	60.2*	57.8*	55.0*	48.9*	42.0*	52
56					56.1*	54.9*	54.0*	52.3*	50.2*	47.5*	41.3*	56
60						49.0*	48.2*	47.1*	45.8*	43.8*	40.7*	60
64							43.1*	42.5*	41.5*	39.9*	38.1*	64
68								38.4*	37.6*	36.6*	35.0*	68
72								34.4*	34.1*	33.2*	32.0*	72
76									30.8*	30.3*	29.4*	76
80										27.6*	27.0*	80
84										24.9*	24.7*	84
88											22.5*	88

## Boom Combination in FJh

Boom Combination in FJh			
Boom length (m)	Insert 6m/(H6)	Boom	
		12m boom base / (H2)	10.5m tapered boom insert / (H4)
24	-	1	1
30	1	1	1
36	2	1	1

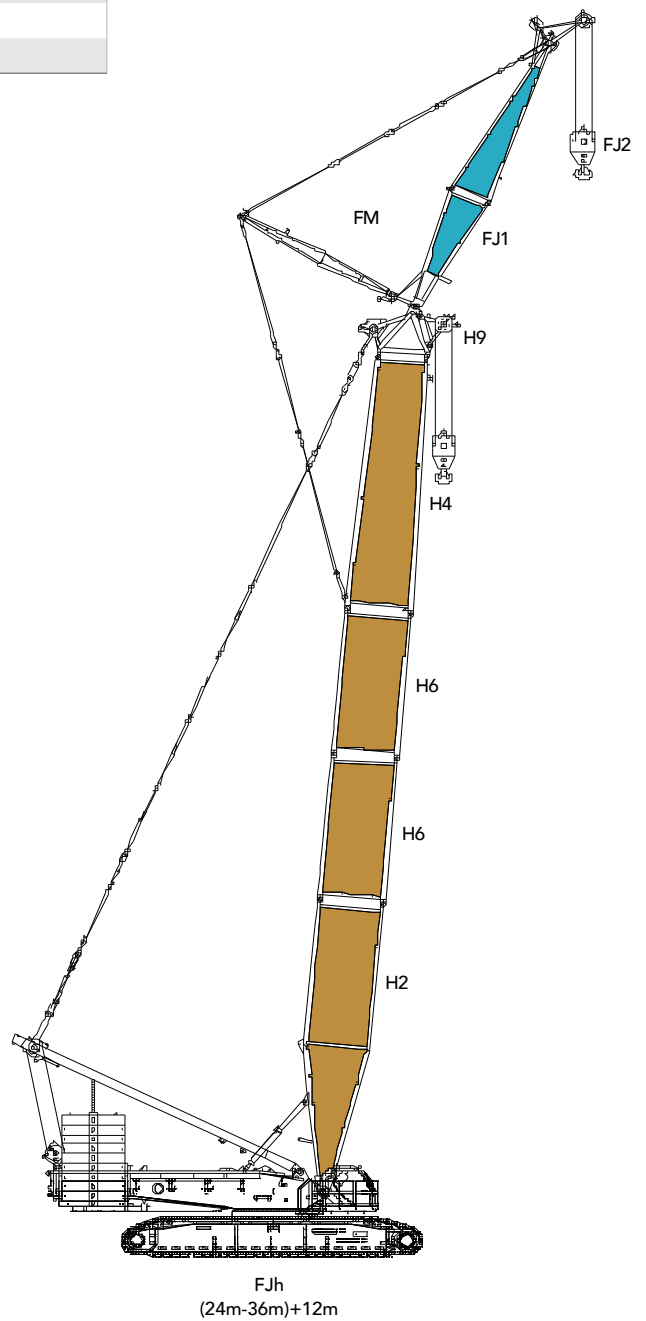



# Working Radius in FJh

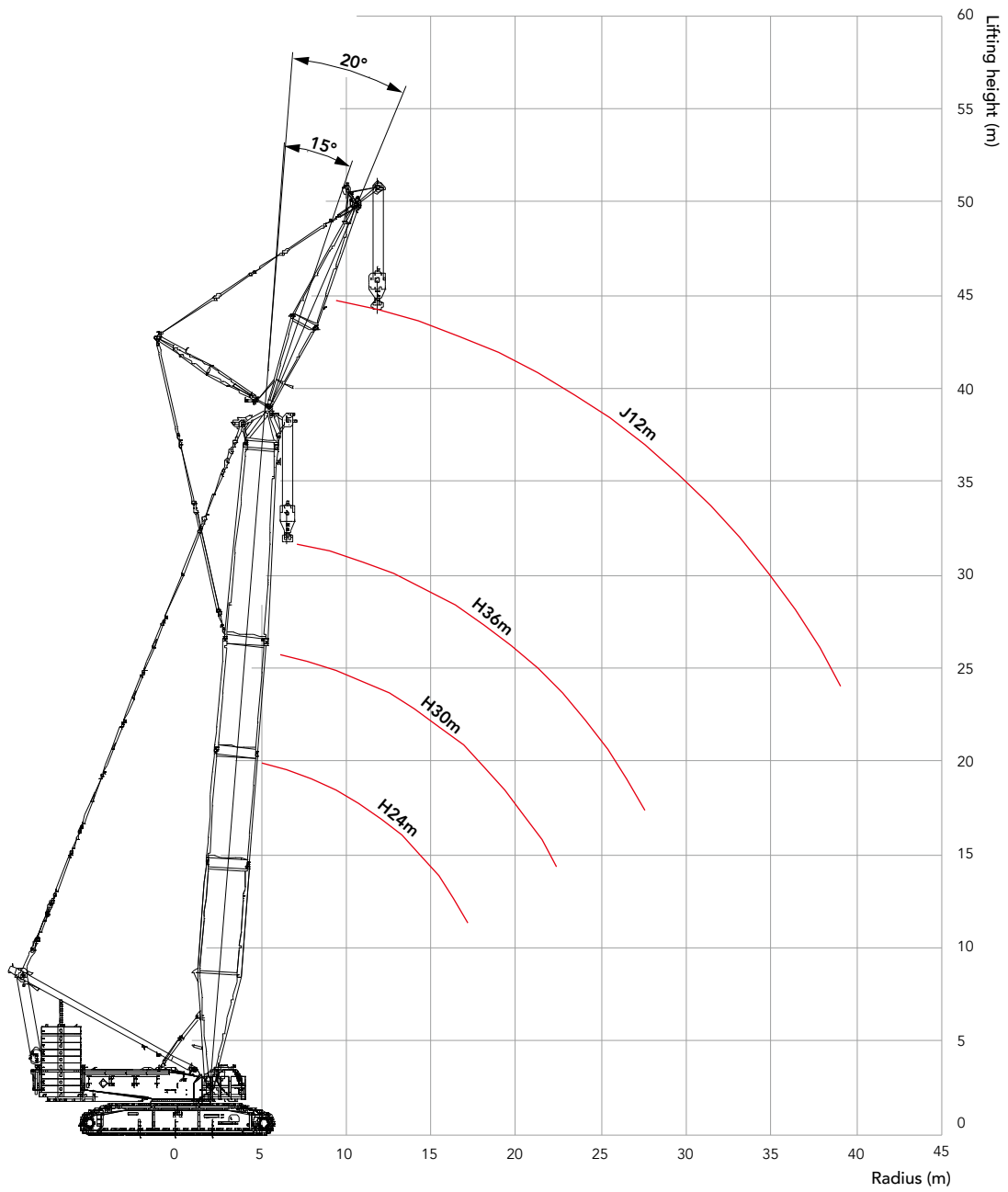

Unit: t

### Load Chart of FJh

SCE6000A Crawler Crane- FJh Configuration 1/2							
Boom length 24m~36m, Jib length 12m, Offset angle 15° , Rear counterweight 200t, Carbody counterweight 50t							
Boom length Radius(m)	24		30		36		Boom length Radius(m)
	Main hook	Aux. hook	Main hook	Aux. hook	Main hook	Aux. hook	
6	558						6
7	564		524		475		7
8	499		464		433		8
9	420	160	395		371		9
10	362	160	342	160	325	160	10
11	317	156	302	160	287	160	11
12	281	147	269	153	257	157	12
14	222	133	220	140	212	145	14
16	179	121	181	128	178	134	16
18	149	112	151	119	151	125	18
20	126	103	128	111	129	117	20
22	108	96.1	110	104	111	111	22
24		90.3	96.3	98.4	97.1	104	24
26		85.0	84.6	92.6	85.5	98.8	26
28		80.4	74.7	87.9	75.7	89.0	28
30		76.7		81.0	67.5	80.6	30
32		73.1		73.9	60.3	73.5	32
34		67.5		67.6		67.3	34
36				62.1		61.9	36
38				57.3		57.0	38
40				52.9		52.7	40
44						45.3	44

## Load Chart of FJh

SCE6000A Crawler Crane- FJh Configuration 2/2							
Boom length 24m~36m, Jib length 12m, Offset angle 20° , Rear counterweight 200t, Carbody counterweight 50t							
Boom length (m) Radius(m)	24		30		36		Boom length (m) Radius(m)
	Main hook	Aux. hook	Main hook	Aux. hook	Main hook	Aux. hook	
6	558						6
7	564		524		475		7
8	498		463		432		8
9	419		394		371		9
10	361	135	342		324		10
11	316	128	301	131	287	133	11
12	281	122	269	125	257	127	12
14	221	111	219	116	211	119	14
16	179	102	181	108	178	111	16
18	149	95.4	150	101	151	105	18
20	126	89.4	128	94.7	128	99.0	20
22	108	83.7	110	89.1	111	94.6	22
24		78.9	96.1	85.2	96.9	89.7	24
26		74.6	84.4	80.9	85.3	85.3	26
28		71.1	74.6	77.0	75.6	81.9	28
30		68.3		73.7	67.3	78.5	30
32		66.0		70.7	60.2	73.9	32
34		63.6		67.9		67.6	34
36				62.3		62.1	36
38				57.4		57.3	38
40				53.0		52.9	40
44						45.4	44

## Boom Combination in FJhDB

Boom Combination in FJhDB			
Boom length (m)	Insert 12m/(H8A)	Boom	
		12m boom base /(H2)	10.5m tapered boom insert/(H4)
36	1	1	1

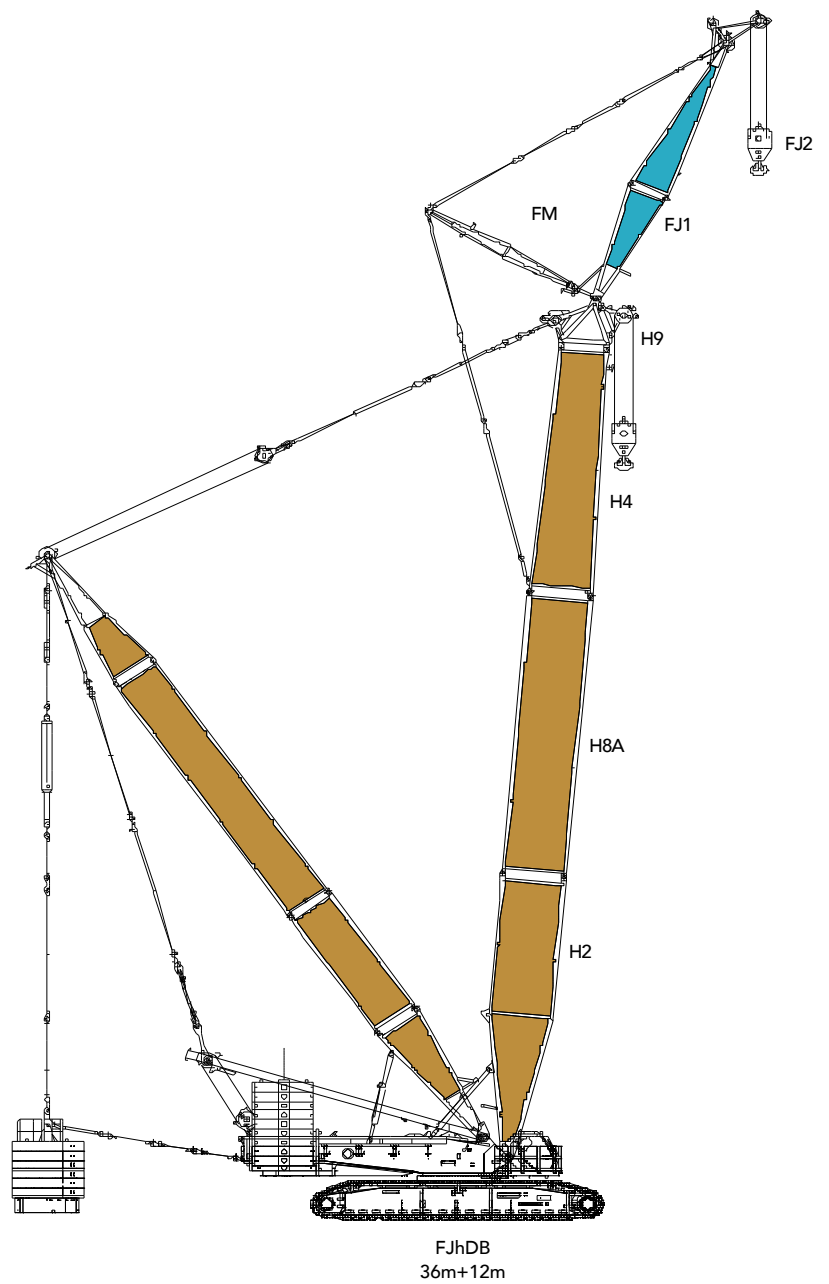

**Working Radius in FJhDB**

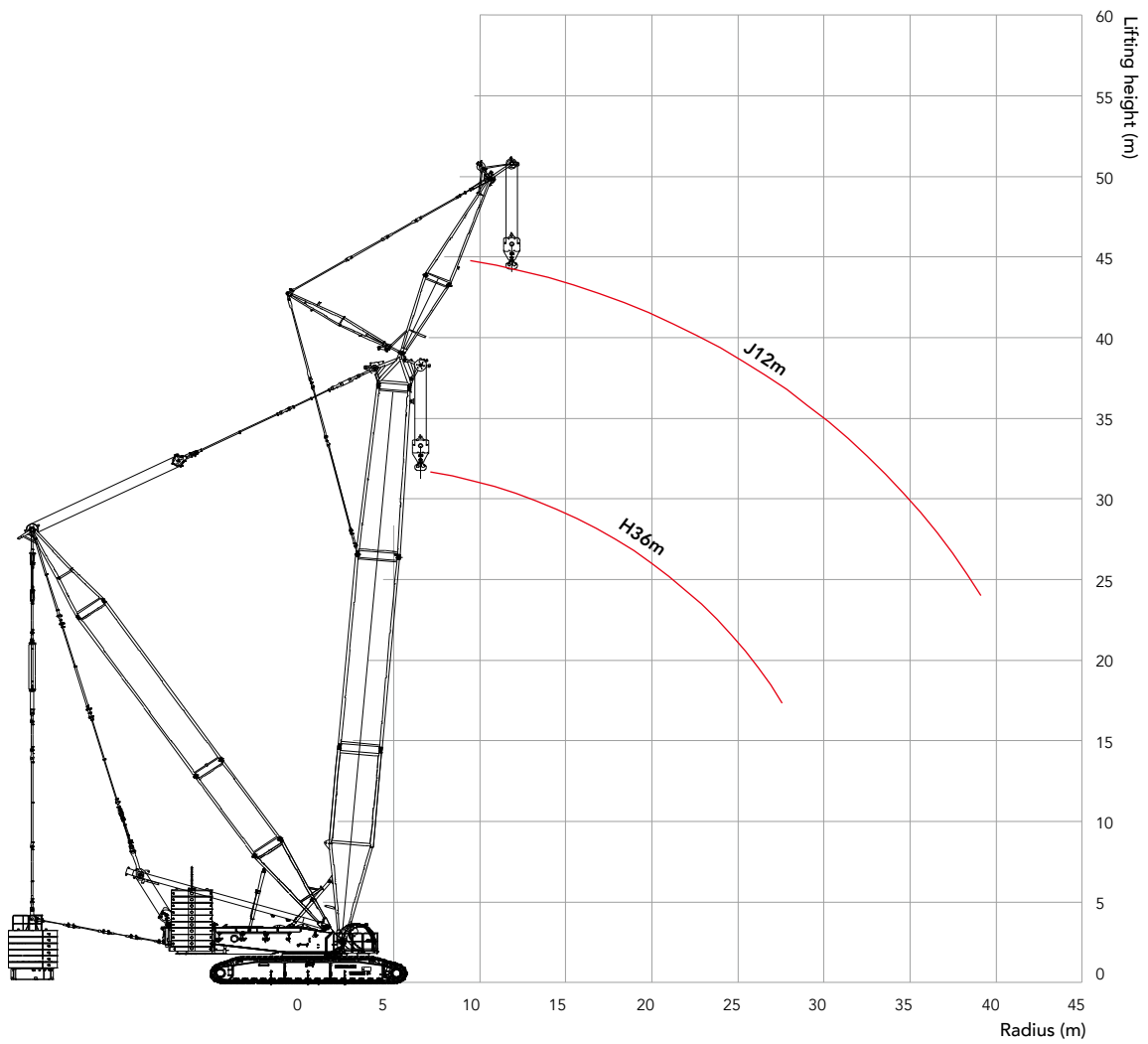

Unit: t

## Load Chart of FJhDB

SCE6000A Crawler Crane- FJhDB Configuration 1/2				
Boom length 36m, Jib length 12m, Offset angle 15° , Superlift radius 16m, Superlift counterweight 250t, Rear counterweight 160t, Carbody counterweight 50t				
Radius(m)	Boom length (m)	36		Radius(m)
		Main hook	Aux. hook	
7		534*		7
8		534*		8
9		538*		9
10		538*		10
11		540	160*	11
12		545	160*	12
14		552	147*	14
16		479	136*	16
18		419	126*	18
20		372	119*	20
22		331	111*	22
24		295	106*	24
26		265	100*	26
28		240	95.1*	28
30		219	90.5*	30
32		201	86.9*	32
34			83.2*	34
36			80.3*	36
38			77.3*	38
40			74.6*	40
44			70.1*	44

**Load Chart of FJhDB**

SCE6000A Crawler Crane- FJhDB Configuration 2/2				
Boom length 36m, Jib length 12m, Offset angle 20° , Superlift radius 16m, Superlift counterweight 250t, Rear counterweight 160t, Carbody counterweight 50t				
Radius(m)	Boom length (m)	36		Radius(m)
		Main hook	Aux. hook	
7		534*		7
8		534*		8
9		538*		9
10		538*		10
11		540	134*	11
12		545	130*	12
14		552	121*	14
16		479	112*	16
18		419	106*	18
20		371	100*	20
22		331	95.2*	22
24		295	90.8*	24
26		265	86.4*	26
28		240	82.5*	28
30		219	79.0*	30
32		201	75.8*	32
34			73.4*	34
36			70.9*	36
38			69.0*	38
40			66.9*	40
44			63.6*	44







## Zhejiang Sany Equipment Co.,LTD

Sany Industrial Park, No.2087 Daishan Road, Wuxing District, Huzhou, Zhejiang  
Province, China Zip 313028  
Service hotline 400 887 8318  
Complaints hotline 400 887 9318

— Gent information —

**Reminder:**

For safe and reliable operation of the diesel engines, please fill Grade IV machines with Grade IV diesel and urea solution conforming to related national standards. Please refer to the operating instructions and related standards for details.

Any change in the technical parameters and configuration due to advancement in technology may occur without prior notice. The machine in the figures may include auxiliary equipment. This brochure is for reference only, and goods in kind shall prevail. Copyright at Sany Heavy Industry. No part of this catalogue may be copied, recorded or used for any purpose without written approval from Sany Heavy Industry.

© Printed in March 2022 in China

[www.sanyglobal.com](http://www.sanyglobal.com)



Instantly scanning for  
reading more